



VEHICLES



AEROSPACE



GEARS & BEARINGS



ENGINEERING



WIND ENERGY



**DISCOVER A MULTITUDE
OF SOLUTIONS**

HARD TURNING

**Cutting materials, tool systems and technologies
for hard turning in the gear, drive and bearing
industry**

DISCOVER A MULTITUDE OF SOLUTIONS



AUTOMOTIVE INDUSTRY

For over 50 years, precision tools from CeramTec have been an integral part of highly productive machining solutions for components from the automotive industry. With our tool solutions, the implementation of concrete cost savings and increased productivity is always top priority. Component examples: Brake discs, gear components, fly wheels, clutch plates, brake components, drive shafts, hydraulic elements, engine/motor components



MACHINERY AND PLANT ENGINEERING

Manufacturing complex components made of different materials with extreme precision and optimal surface quality in an economic way – that is the basic structure of requirements for which we work together with our customers to create innovative, cost-efficient machining solutions. Component examples: Gearbox housing, flanges, guides, shafts, rollers



WIND ENERGY

In the field of wind energy, components mostly require special machining solutions, since the components involved are often especially large. Strict tolerance requirements and a high level of surface quality place extreme demands on the cutting materials and tool holders. By observing and analysing the determining factors for machining, we are able to provide our customers with extremely efficient and cost-effective machining solutions. Component examples: Rotor flange, rotor blade connections, planetary gear holders, gearbox housing, gear components

AEROSPACE

The aerospace industry places extremely high demands on machining. In this field, machining capacity and process safety are the decisive parameters, and our CSA cutting materials together with our Monsoon Tool Technology tools are the optimal solution. Component examples: Jet engine components such as blisks



GEAR TECHNOLOGY, DRIVE TECHNOLOGY AND BEARING INDUSTRY

Surface quality, tolerances and the tool life of the cutting materials are the standards for quality for hard machining. Our unique range of cutting materials made of PcBN and ceramic, together with our perfectly matched tools, set the bar in this industry. In practice, this results in highly efficient and cost-effective machining. Component examples: Gear wheels, shafts, large gearbox components, bearing rings and rolling elements

AUTOMOTIVE INDUSTRY

MOTOR INDUSTRY

The high-performance materials that are used in this industry require cutting materials that ensure an extremely high level of process reliability and a consistently high quality level. Our cutting materials and tools are the perfect solution.

Component examples: Connecting rods, pulley wheels, cylinder heads, cylinder liners

TRANSPORT

When machining components for the transport industry, special solutions are often required in order for the machining process to remain economical and efficient. Our tools and cutting materials make these kinds of solutions possible.

Component examples: Wheel rims, shafts, bearings

AGRICULTURAL AND CONSTRUCTION MACHINERY

We offer highly efficient bearing solutions for components for agricultural and construction machinery. Our range of solutions are currently used for machining of soft steel as well as processing cast iron and hardened parts.

Component examples: Brake components, drive shafts, hydraulic elements, motor components

AUTOMOTIVE

For over 50 years, precision tools from CeramTec have been an integral part of highly productive machining solutions for components from the automotive industry.

Component examples: Brake discs, brake drums, fly wheels, connecting rods, gear components, engine blocks

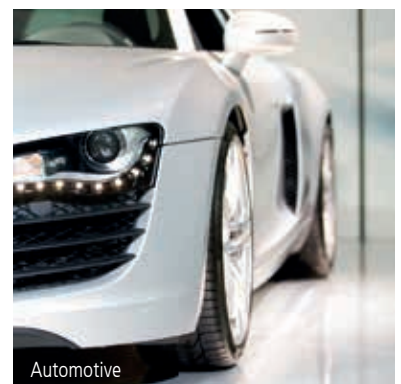





SPK hard turning solutions	6
SPK hard turning grades	7
Solid PcBN inserts for hard turning – simply better	8 - 9
Scope of Application.....	10
Recommendations.....	11 - 12
Insert types	13
IKS-PROMINI and System S3 - Toolsystems for hard-part turning.....	14
Customized solutions	15
Machining examples.....	16 - 19
Inserts for hard turning	20 - 35
• Multi-tipped	20 - 27
• Solid	28 - 35
Tool systems for hard turning	36 - 37
• Shaft tools.....	38 - 45
• CMS tools.....	46 - 53
• Boring bars.....	54 - 56
S3 tool system for solid PcBN	57

SPK hard turning solutions

Increasingly, components made from hardened steel such as those used in the gear, drive or bearing industries are being machined using hard turning with modern cutting materials and tools. Accordingly, the high standards being set in surface quality dimensional and shape accuracy must be achieved with process reliability. Components in mass or volume production must be manufactured with the highest possible efficiency. In this context, hard turning is the production process that facilitates a drastic reduction in processing times, which leads to a significant decrease in machining costs and a measurable increase in productivity. Further general conditions of production, corresponding to end user benefits, include high-precision at a reasonable price at the desired quality.

A hard turning process that is technically optimised for maximum efficiency is therefore essential.

The goal is to incorporate not only the appropriate high-performance tool systems, but also high-end machining technology, know-how and fine-tuned tool logistics into the hard turning process.

With its extensive product and service portfolio, SPK Cutting Tools – known as “SPK+ The Productivity Experts” – is rising to this challenge. The hard turning process is tailored to customer requirements – from the cutting edges and technology used up to machine application and tool logistics.

i SPK hard turning solutions for:

- ⊕ Significantly reduced machining times
- ⊕ Increased process reliability
- ⊕ High process flexibility
- ⊕ Excellent surface qualities
- ⊕ Continuous and interrupted cuts
- ⊕ Cutting material for hard/soft transitions
- ⊕ High dimensional and shape accuracy

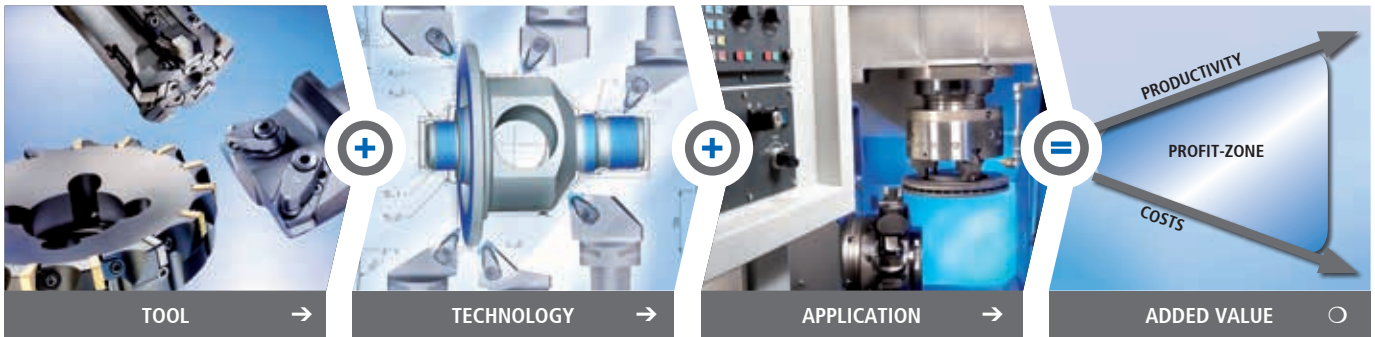

NEXT GENERATION MATERIALS FOR HIGH-SPEED HARD TURNING AND GREATER MACHINING FREEDOM THANKS TO:

- Up to 200% more tool life
- Cutting speed up to 240 m/min
- With a feed rate up to 0.5 mm
- new machining strategies with solid inserts allow short machining times

The brand new cutting material and insert system for hard turning has been especially developed for high-performance hard turning operations. All types of cutting material have an exceptionally high edge stability and minimal crater wear. For the entire application spectrum – from continuous to lightly and heavily interrupted cuts – the high-perfor-

mance specialists are well prepared with the range of new grades, which means that users can use the cutting materials to design the optimal hard turning process for their respective hard turning application.

Multi-tipped and also solid indexable inserts are available for hard turning operations.

i SPK hard turning grades

Grades	Solid	Multi-tipped
WXM 155	●	
WXM 255	●	●
WXM 355	●	●
WXM 455		●
WBN 565		●

WXM 155 The cycle time pro

This new type of cutting material is setting new standards when it comes to efficiency. High thermal stability and red hardness make it extremely wear resistant. Materials with a hardness of up to 62 HRC can be

easily machined with speeds up to $v_c = 180$ m/min in continuous cut. The Solid versions support the flexible design of the hard turning processes. Adjusting the process design in this way

can reduce machining times by 50% in excess of when compared to multi-tipped PcBN.

WXM 255 The dimensional accuracy expert

The extraordinary wear resistance of this cutting material is setting new standards for shape and dimensional accuracy. Thanks to its thermally highly-stable binder and low chemical affinity to

chrome, this grade is particularly suitable for machining hardened bearing steels. Extremely high tool lives can be achieved reliably in continuous cut. The outstanding crater wear resistance reduces the risk of

cutting edge breakage and increases the process reliability.

WXM 355 The all-rounder

Regardless of the operation, WXM355 is the right choice. The balance of toughness and wear resistance make this grade ideal for case-hardened steel; the tool life is also extended by up to 50%. The Solid

version allows for reliable preturning as well as drawn cuts.

WXM 455 Specialist for interrupted cuts

The WXM 455 is the top choice for machining of heavily interrupted cuts. For these applications, the cutting material's toughness and resistance to abrasion is important. This grade offers a high degree

of toughness and, thanks to its optimised wear resistance, it can be implemented for machining with cutting speeds up to $v_c = 220$ m/min with heavily interrupted cuts.

WBN 565 The uncoated all-rounder

For moderately and more heavily interrupted cutting, the WBN 565 shows its performance as an all-rounder during hard turning. Its balance of toughness and wear resistance opens up new possibilities for

applications with heavily interrupted cuts with the highest process reliability. Owing to its impressive performance, the WBN 565 is also an all-rounder in terms of tool life and enables you to implement extremely

efficient hard turning processes.

Solid PcBN inserts for hard turning – simply better

WITH SOLID PCBN FOR HARD TURNING FOR:

- NEW MACHINING STRATEGIES
- HIGHER CUTTING DATA
- AND HIGHER PROCESS RELIABILITY

Multi-tipped PcBN inserts have established themselves for hard turning gears, bearings and drive elements. They are in daily use and are used for all typical types of applications. Limiting factors, resulting from the length of the PcBN insert and the solder connection between the PcBN insert and

the carbide body, are often accepted. These limiting factors can be observed in the cut allocation (cutting depth is limited by the length of the PcBN insert), the cutting speed as well as the operation time (desoldering the PcBN insert due to levels of heat that are too high). Solid, low PcBN

contend inserts are not affected by these limitations and offer numerous application advantages.

ADVANTAGE:

NEW MACHINING STRATEGIES

Solid PcBN indexable inserts offer optimal cut allocation without cutting edge length limitation; this can be seen in the example of gear wheel processing with a hard to soft transition.

The machining time of a hard turning component can thus be shortened considerably. As can be seen from the customer example, the machining time could be reduced by 36% by implementing a preturning strategy.

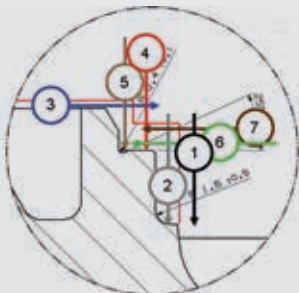

Seven cuts with a multi-tipped insert

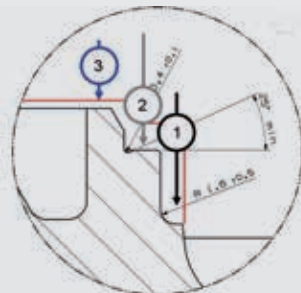

Three cuts with a solid insert

ADVANTAGE: DRAWN CUTS

WITH SOLID PCBN INSERTS

Solid PcBN indexable inserts make it possible to carry out hard machining processes with drawn cuts. Small approach angles are used for drawn cuts. This means that a large part of the cutting edge is in contact with the workpiece. With solid PcBN indexable inserts, approx. 2/3 of the insert length is usable. It allows for high feed rates and also outstanding surface

qualities, and thus considerably reduces the processing time required for a part. The processing time required for a part can thus be reduced considerably. Another advantage is that the wear along the cutting edge is distributed along a considerably longer length in comparison to multi-tipped PcBN inserts. The tool life and process reliability can be increased greatly using

this machining technique.

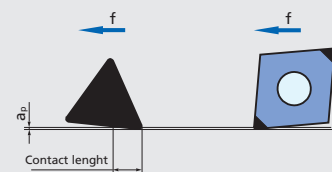

Drawn cut

Conventional cut

ADVANTAGES

Solid PcBN inserts for hard turning – simply better

ADVANTAGE:

PRETURNING MACHINING TECHNIQUE

With preturning, a type of facing method, maximum removal rates and hard to soft transitions can sometimes be achieved in one work step. This work step can also often be performed by implementing an insert geometry. The preturning machining technique does not just considerably increase efficiency, but also reduces the machining costs because a smaller range of tools is required.



Grooving below angle to dimension



Facing/preturning



Retracting

ADVANTAGE:

HIGHER CUTTING DATA AND LONGER OPERATION TIMES

Average cutting data for hard turning with soldered PcBN inserts is characterised as follows: a moderate cutting speed of 150 m/min, the feed rate is approx. 0.08 - 0.11 mm with a depth of engagement of a few tenths of a millimetre.

Here, solid PcBN inserts enable moderate cutting speeds of approx. 180 m/min, with feed rates of 0.2 - 0.25 mm at the same moderate depth of engagement. Because the inserts are not subject to thermal limitations, they result in a considerable increase of the removal rate by approx. 35% and improved efficiency of the hard turning process. Even with longer operating times, there is no risk of the PcBN tip unsoldering. This allows you to machine larger hard

turning components while ensuring process reliability.

ADVANTAGE:

GREATER PROCESS RELIABILITY

Only solid PcBN indexable inserts offer optimised cut allocation, zero risk of unsoldering and very good wear distribution during preturning and drawn cuts. This results in a

very high level of process reliability during daily production. Process reliability is an important quality feature for all hard turning processes because hard turning is usually the last production step. Process reliability is of particular importance in mass production and machining large components.

The performance of the solid PcBN indexable inserts is enhanced by the IKS-PROMini clamping system that was specially designed for the use with solid PcBN indexable inserts and to meet the requirements of hard turning. It is equipped with CeramTec ODC Force Technology for optimum clam-

ping force distribution and also features CeramTec Easy Change technology that enables fast and easy insert change – even when they are in overhead position. For solid PcBN indexable inserts, we should bear in mind that the whole is more than the sum of its parts (or advantages). As a

result, solid PcBNs enable outstanding, efficient and reliable hard turning operations that meet the highest requirements in terms of workpiece surface quality.

Scope of application

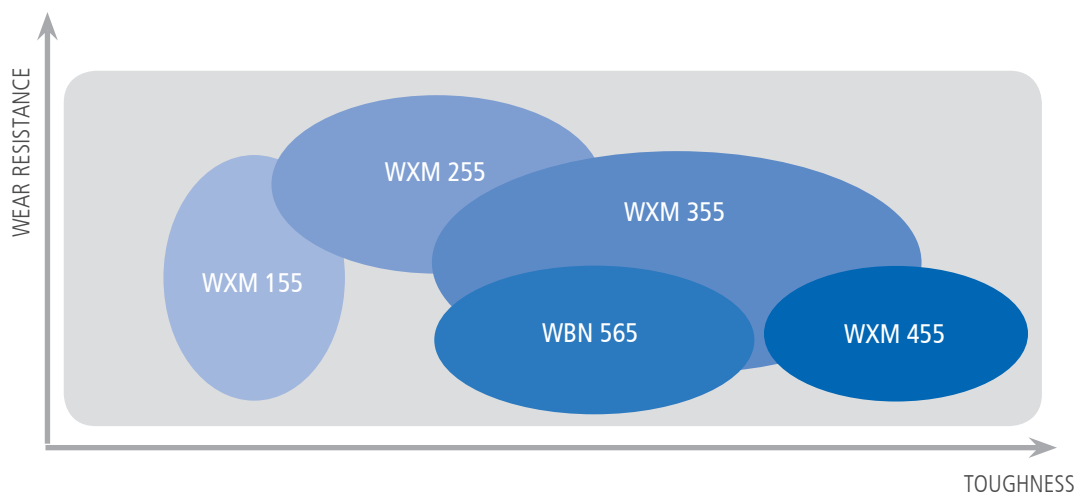
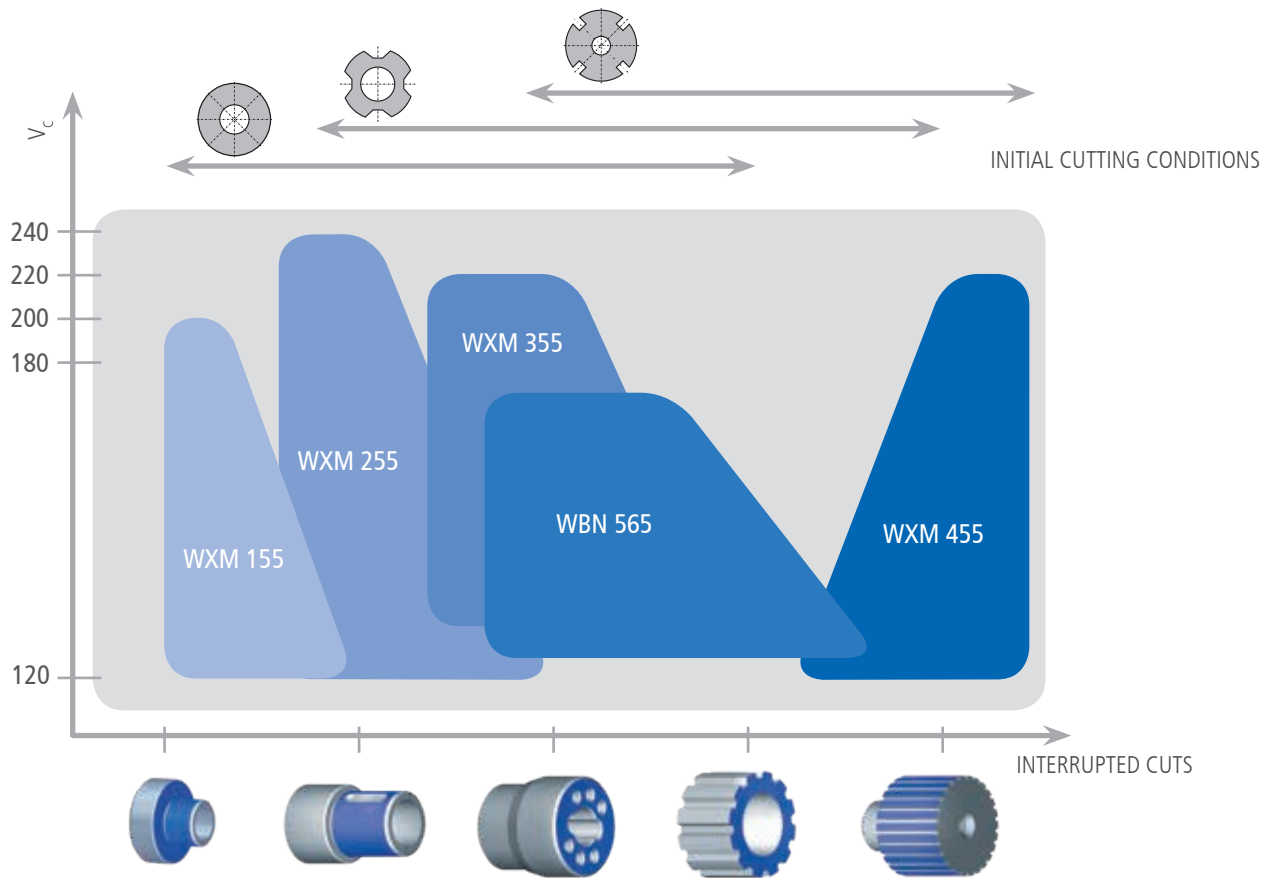

CUTTING SPEED RANGES

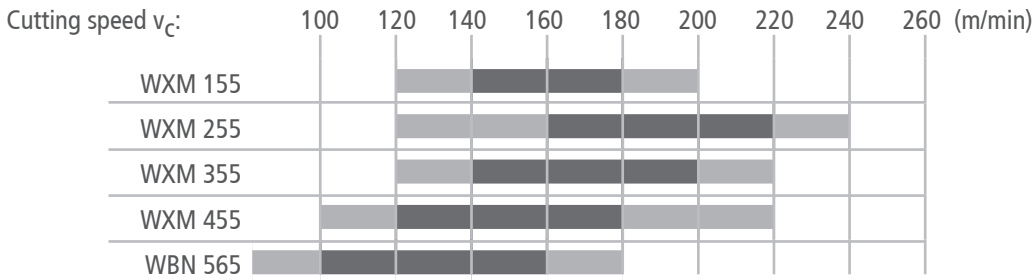

FEED RATE RANGES

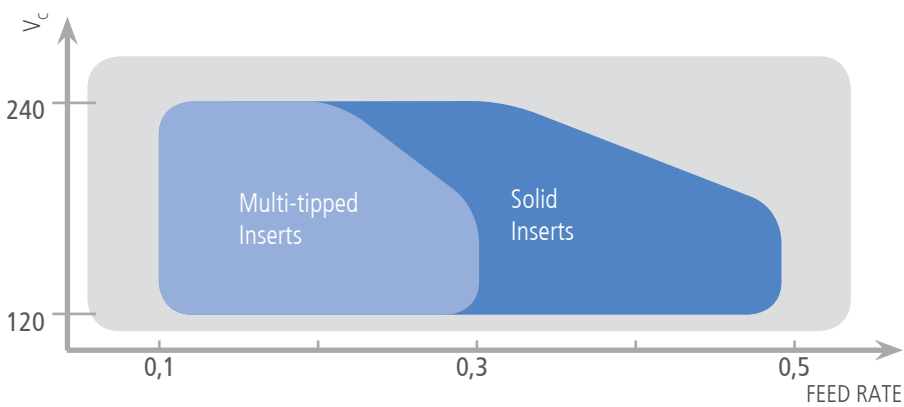
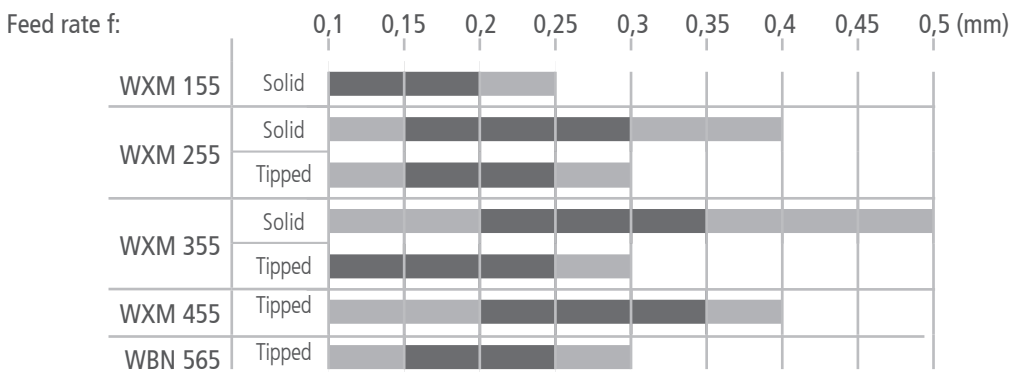

Recommended applications

Recommended values for turning hardened steels

Hardness (HRC)	Cutting speed v_c (m/min)		Recommended value for chip thickness h (mm)
	Recommended value	Range	
48	300	150 - 400	≤ 0.18
52	250	130 - 300	≤ 0.16
56	200	100 - 260	≤ 0.14
60	180	80 - 240	≤ 0.12
64	150	80 - 180	≤ 0.10



CUTTING DEPTHS a_p :

Conventional hard turning:
 $a_p = 0.1 - 0.5$ mm

Hard to soft transition:
 $a_p \text{ max} = 4.0$ mm

DETERMINING THE FEED RATE VALUES

When working with a small depth of cut for hard turning, the chips will have a "C" shape with a specific thickness h . In order to obtain the optimum chip

formation, the feed rate should be determined according to the given formula, depending on the variable chip thickness h .

$$f = h \cdot M$$

Example: recommended feed rate

Hardness 60 HRC

$h \leq 0.12$

with $r_\epsilon = 1.6$ mm where $a_p = 0.5$ mm

Feed rate $f = 0.12 \times 1.4$ mm = 0.17 mm

Factor M for corner radii

a_p (mm)	Corner radius r_ϵ			
	0,4	0,8	1,2	1,6
0,1	1,5	2,1	2,5	2,8
0,2	1,15	1,6	1,8	2,0
0,3	1,0	1,3	1,5	1,7
0,4	1,0	1,2	1,3	1,5
0,5		1,1	1,2	1,4

Factor M for round inserts

a_p (mm)	Diameter d (mm) = IC		
	6,35	9,52	12,70
0,3	2,3	2,9	3,3
0,5	1,8	2,2	2,6
1,0		1,6	1,9
1,5		1,4	1,6
2,0			1,4

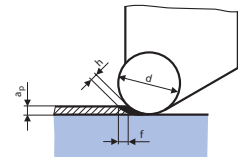
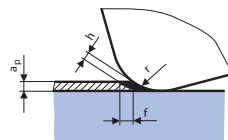

DRAWN CUTS:

- with Solid inserts, approx. $\frac{2}{3}$ of the insert length is usable
- select a small actual approach angle
- take advantage of good surface qualities by setting high feed rates

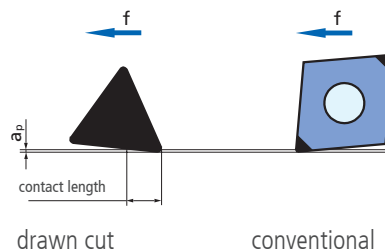

DESIGNATION SYSTEM FOR INSERTS

Designation of multi-tipped inserts with ZZ geometry

Number of cutting edges
(4 corners multi-tipped)

Length of PcBN insert > 2 mm

CNGA 120408 T - LL 95Z025

Chamfer

Approach angle

Width of the ZZ chamfer

Designation of Solid inserts with IKS-PROMini clamping system

Solid version

SNGX 090408 S - S - MDO

Chamfered and rounded

IKS-PROMini clamping notch

Designation of Solid inserts with System S3 for inscribed circle 12,70 mm

Solid version

SNGX 090408 S - S - SDO

Chamfered and rounded

System S3 IKS-PRO based clamping notch

Types of HD-Line inserts according to ISO 1832

Symbol	Illustration	Description	SPK PcBN grades
B		one-side, multi-tipped PcBN inserts, 2 corners	WXM 255, WXM 355, WXM 455, WBN 565
C		one-side, multi-tipped PcBN inserts, 3 corners	WXM 255, WXM 355, WXM 455, WBN 565
D		one-side, multi-tipped PcBN inserts, 4 corners	WXM 255, WXM 355, WXM 455, WBN 565
L		two-side, multi-tipped PcBN inserts, 4 corners	WXM 255, WXM 355, WXM 455, WBN 565
M		two-side, multi-tipped PcBN inserts, 6 corners	WXM 255, WXM 355, WXM 455, WBN 565
N		two-side, multi-tipped PcBN inserts, 8 corners	WXM 255, WXM 355, WXM 455, WBN 565
S		Solid insert	WXM 155, WXM 255, WXM 355
F		one-sided full face laminated	WXM 455

IKS-PRO*Mini* and System S3 for hard turning

Our goal is to provide the ideal tool for every hard turning application. In order to meet the extremely high

demands on positional and shape tolerances as well as surface quality, we have developed clamping systems which, in

combination with our cutting materials, can reliably meet these strict tolerance requirements.

IKS-PROMINI FOR SMALL INSCRIBED CIRCLES (≥ 6.35 MM)

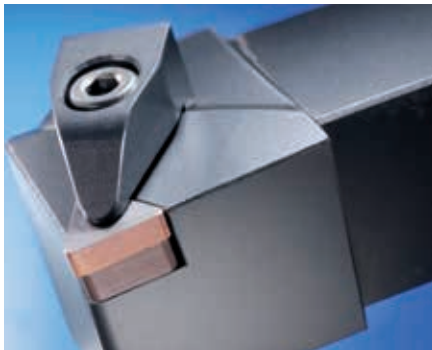

The IKS-PROMINI clamping system is based on the IKS-PRO. The proven notch geometry

used in IKS-PRO has been further developed in order to meet the requirements of hard turning with solid inserts with an inscribed circle of 9.52 mm. The form-fit and force-fit connection ensures the retraction of the insert into the insert seat and guarantees an extremely stable and secure clamp for hard turning. The cutting forces applied on the insert and the clamping system during hard fine machining are thereby optimally distributed across the entire insert seating. This makes the IKS-PROMINI the ideal clamping system for achieving narrow tolerances using both continuous and lightly

to heavily interrupted cuts with absolute process reliability. Moreover, thanks to its practical, simple and fast operation, IKS-PROMINI allows users to meet the highest quality requirements quickly, safely and easily on a daily basis.

SYSTEM S3 FOR LARGE INSCRIBED CIRCLES (≥ 12.7 MM)



The S3 tool holder and clamping system offers extreme process reliability along with

minimal tool maintenance costs for hard turning with solid PcBN inserts with an inscribed circle of 12.70 mm. Hard turning procedures with long operation times and high cutting data require precision tool solutions that offer the high level of process reliability while keeping tool maintenance costs to a minimum. The design and the materials selected for the S3 system have been developed with precisely these requirements in mind. The S3 system's unique characteristics are a result of its innovative ODC Force clamping technology, optimised

design and the use of a modern combination of materials. The optional high-temperature-resistant material version of the insert seating prevents the insert from expanding or becoming embedded in the insert seating. This means that the insert can be clamped extremely securely and reliably. This ensures maximum dimensional accuracy of the workpiece and a long tool life.

i Advantages of System S3

- ODC Force clamping technology for optimal clamping force distribution



- Clamping in front of the centre of the insert



- S3 with heat protector equipment thanks to a ceramic shim made of high performance ceramic



- The insert seating does not expand thanks to high-temperature-resistant tool holder material (optional)

CUSTOMISED SOLUTIONS

The differing size and complexity of hardened components often demand sophisticated machining solutions that use special tools. Our engineering team assists customers with the knowledge of using as many standard tools as possible and as many special tools as required. Tool solutions are conceived for achieving

optimum machining results and the highest level of efficiency.

Solid and multi-tipped versions are available for implementing customised inserts. As a manufacturing company, we produce special insert geometries and tools in our production facility in Germany. This gives our customers the advantage that we

can supply even the most complex geometries within a short period of time. If adjustments need to be made on existing tools, these can also be performed quickly and flexibly.

WIPER TECHNOLOGY

i Advantages of wiper technology

ZZ GEOMETRY

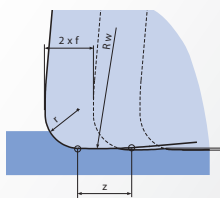

Equal feed rate
= doubled surface quality

Doubled feed rate
= machining times cut down by half

STANDARD GEOMETRY

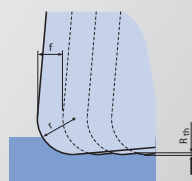

Increase in production quality

Increase in productivity

Every oak was an acorn – this is probably the best way to describe the enormous increase in performance which can be achieved in finish-turning when using the ZZ geometry. The use of cutting inserts with a ZZ geometry allows for significantly higher surface qualities to be achieved in comparison with inserts featuring standard geometries. Alternatively, the main machining times can be reduced considerably without any consequences to high surface qualities. Therefore, the ZZ geometries represent one of the most efficient ways of increasing productivity in machining, especially in finishing operations.

TYPES OF CUTTING EDGES

A range of different tried and tested chamfer geometries are available for the various hard turning operations. The chamfer selection will not only influence the tool life, but also the surface quality

and dimensional accuracy of the work-piece. Optimising the chamfer may also cause a supplementary increase in productivity.

i Chamfer geometries

T-chamfer:

for continuous cuts

❖ 44 for smooth cuts



S-chamfer: with rounding

❖ 46 for lightly interrupted cuts

❖ 47 for heavily interrupted cuts



Additional chamfer geometries are available in different designs.

MACHINING TIME REDUCED BY 46 % TOOL LIFE INCREASED BY 280 % TURNING OF AN AXLE SHAFT USING WXM355

REQUIREMENTS:
- REDUCTION OF MACHINING TIME
- INCREASING TOOL LIFE

CONDITIONS:
- CONTINUOUS CUT
- 62 HRC
- HARDENED STEEL

WXM 355

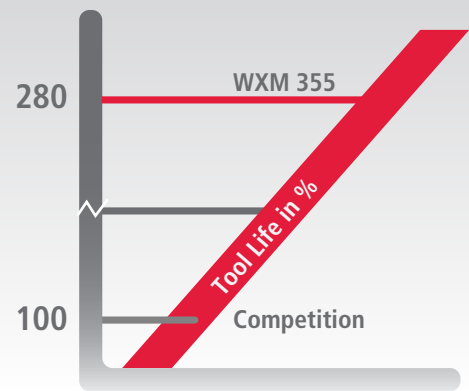
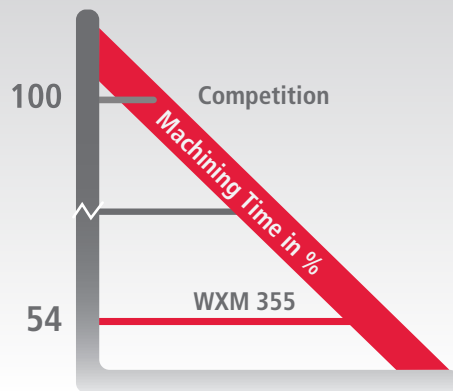

SPK-ENGINEERING FOR INCREASING EFFICIENCY

- HARMONIZING OF WORKPIECE- AND CUTTING MATERIALS
- USE OF SOLID-CBN INSERTS
- DEFINITION OF MACHINING STRATEGY
- DEFINITION OF CUTTING DATA

Starting situation (multi-tipped)

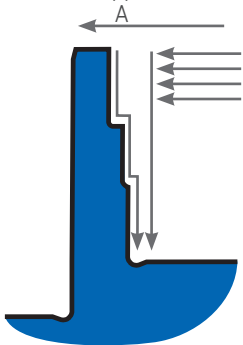

Optimisation of SPK Cutting Tools (Solid)

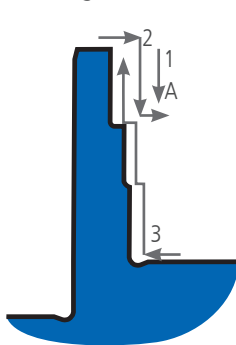

Turning of an axle shaft using WXM 355

	Competition	SPK
Grade	PcBN	WXM 355
Insert	CNGA 120408 T-BL	TNGX 110408 S-S MDO
Cutting speed v_c :	130 m/min	130 m/min
Feed rate f :	0,13 mm	0,13 mm
Depth of cut a_p :	bis 0,2 mm	bis 1,0 mm
Machining Time:	100 %	54 %
Tool Life:	120 pcs.	340 pcs.
Number of cuts:	7	3

The machining time can be reduced by 46% through the use of solid inserts, which allow for the optimisation of cut allocation from 7 to 3 cuts.

MACHINING TIME REDUCED BY 36 % TURNING OF A GEAR WHEEL USING WXM355

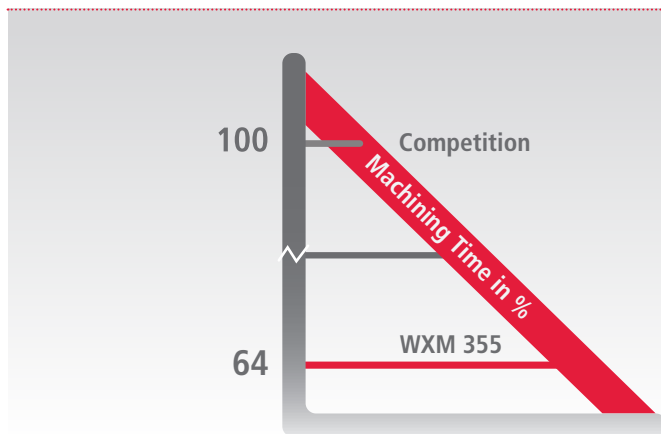

REQUIREMENTS:

- REDUCING MACHINING TIME
- SURFACE QUALITY

CONDITIONS:

- 62 HRC
- HARD-SOFT TRANSITION

WXM 355

SPK-ENGINEERING FOR INCREASING EFFICIENCY

- DEFINITION OF MACHINING STRATEGY
- DEFINITION OF CUTTING DATA

Turning of a gear wheel using WXM 355

	Competition	SPK
Grade	PcBN	WXM 355
Insert	CNGA 120412 T-BL	TNGX 110412 S-S MDO
Cutting speed v_c :	150 - 200 m/min	150 - 200 m/min
Feed rate f :	0,1 - 0,2 mm	0,1 - 0,2 mm
Depth of cut a_p :	bis 1,0 mm	bis 4,0 mm
Machining Time:	100 %	64 %
Number of cuts:	7	3

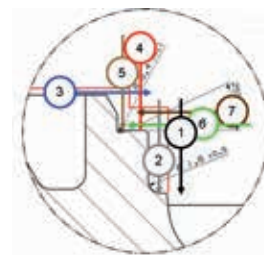

before

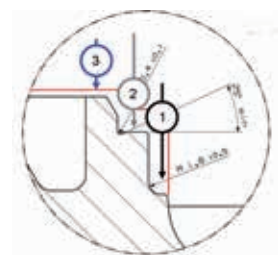

after

INCREASED TOOL LIFE

TURNING OF A WAYDISC

INTERNAL MACHINING INCREASED UP TO 150%

EXTERNAL MACHINING INCREASED UP TO 300%

REQUIREMENTS:
 - INCREASE TOOL LIFE
 QUANTITY
 - NO BURR FORMATION

CONDITIONS:
 - 60-62 HRC
 - DRY CUTTING
 - CASE HARDENED STEEL

WXM 355

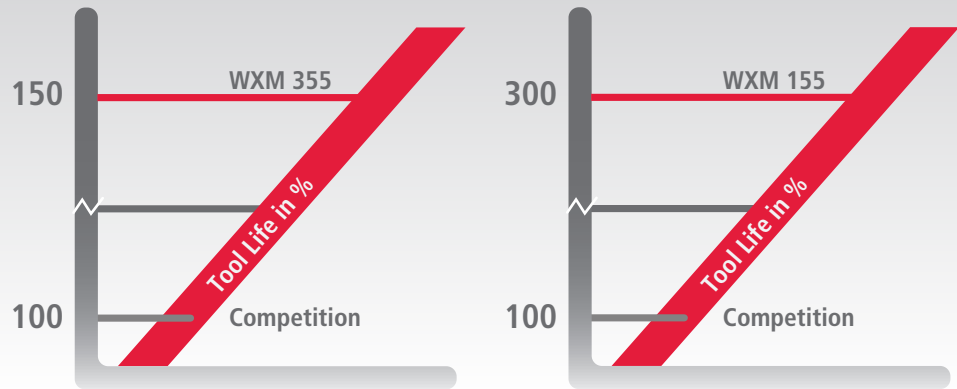

SPK-ENGINEERING FOR INCREASING EFFICIENCY

- HARMONIZING OF WORKPIECE- AND CUTTING MATERIALS
- DEFINITION OF MACHINING STRATEGY
- DEFINITION OF CUTTING DATA



Machining: Turning of a waydisc with WXM 355 / WXM 155

	Internal Machining		External Machining	
	Competition	SPK	Competition	SPK
Grade:	PcBN	WXM 355	PcBN	WXM 155
Insert:	DCGW 11T308	DCGW 11T308 S-BL	RNGN 060300	SNGX 090412 S-S MDO
Cutting speed v_c :	170 m/min	170 m/min	180 m/min	180 m/min
Feed rate f :	0,07 - 0,09 mm	0,07 - 0,09 mm	0,18 mm	0,18 mm
Depth of cut a_p :	0,2 mm	0,2 mm	0,2 mm	0,2 mm
Tool Life:	200 pcs.	300 pcs.	60 pcs.	175 pcs.

TOOL LIFE QUANTITY INCREASED BY 175 % TURNING OF A GEAR WITH WITH WXM 355

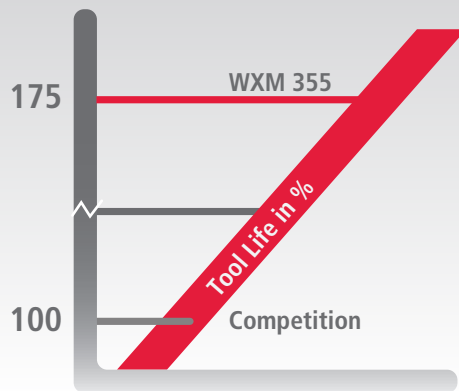

REQUIREMENTS:

- INCREASE TOOL LIFE QUANTITY
- BURR FORMATION
- SURFACE QUALITY

CONDITIONS:

- CONTINUOUS CUT
- DRY CUTTING
- 16MnCr5
- 58-62 HRC

WXM 355

SPK-ENGINEERING FOR INCREASING EFFICIENCY

- HARMONIZING OF WORKPIECE- AND CUTTING MATERIALS
- DEFINITION OF CUTTING DATA

Machining: Turning of a gear with WXM 355

	Competition	SPK
Grade:	PcBN	WXM 355
Insert:	CNMA 120408 T-D	CNGA 120408 S-LL
Cutting speed v_c :	180 m/min	180 m/min
Feed rate f :	0,1 mm	0,1 mm
Depth of cut a_p :	0,15 mm	0,15 mm
Tool Life:	120 pcs.	210 pcs.

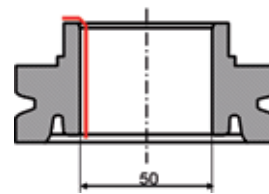

Competition



WXM 355

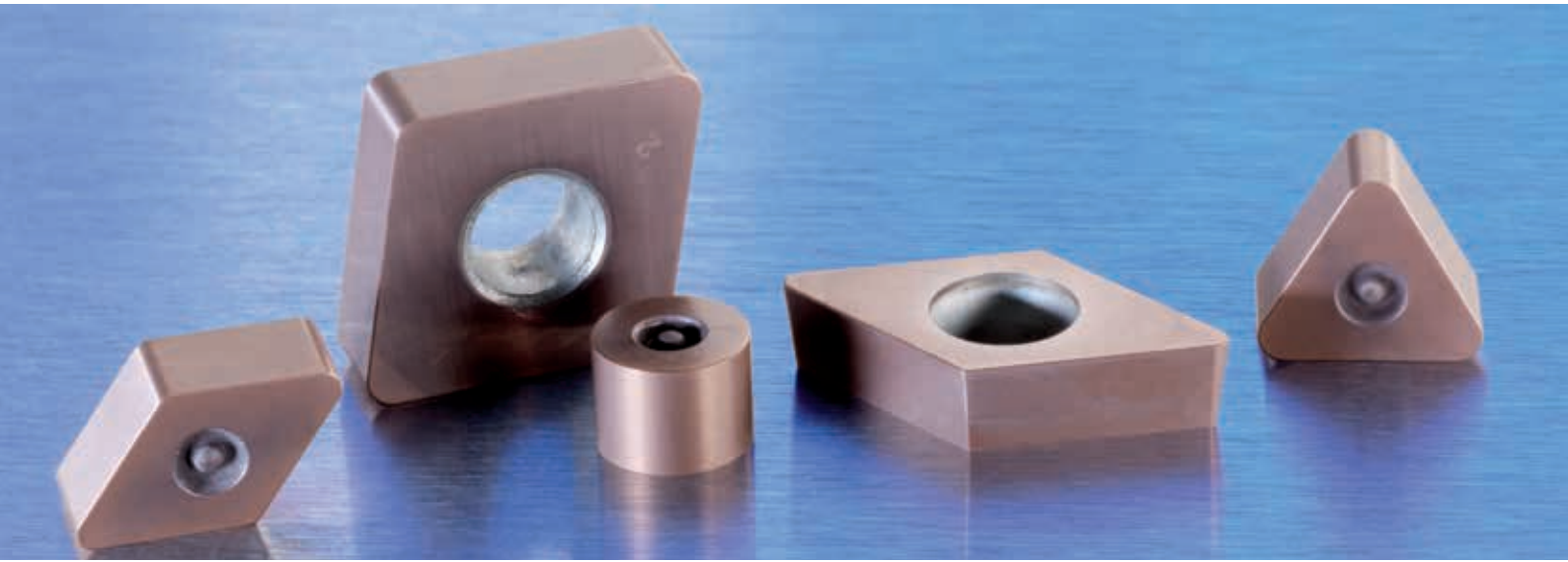

INSERTS IN MULTI-TIPPED AND SOLID VERSIONS

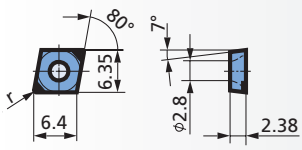
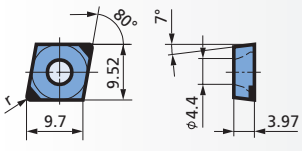
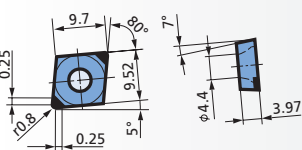
INSERT	ISO	GRADE	SPK-REF. NO.	
CCGW 06 02 .. - BL 	CCGW 06 02 02 T - BL	WXM 255	12.57.405.44.3	
	CCGW 06 02 04 T - BL	WXM 255	12.57.406.44.3	
	CCGW 06 02 04 S - BL	WXM 455	12.57.406.46.5	
	CCGW 06 02 04 S - BL	WBN 565	22.57.429.46.7	
CCGW 09 T3 .. - BL 	CCGW 09 T3 04 S - BL	WXM 355	12.57.401.46.4	
	CCGW 09 T3 04 T - BL	WBN 565	22.57.401.44.7	
	CCGW 09 T3 08 T - BL	WXM 255	12.57.402.44.3	
	CCGW 09 T3 08 S - BL	WXM 355	12.57.402.46.4	
	CCGW 09 T3 08 T - BL	WBN 565	❖22.57.402.44.7	
	CCGW 09 T3 08 S - BL	WBN 565	⊗22.57.402.46.7	
CCGW 09 T3 08 S -BL -95Z025 	CCGW 09 T3 08 S - BL 95Z025	WXM 255	12.57.407.44.3	
	CCGW 09 T3 08 S - BL 95Z025	WXM 455	12.57.407.46.5	

i Chamfer geometries

T-chamfer:

for continuous cuts

❖ 44 for smooth cuts

S-chamfer: with rounding

⊗ 46 for lightly interrupted cuts

❖ 47 for heavily interrupted cuts

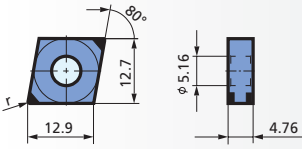
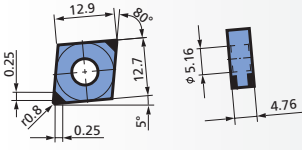

Multi-tipped

INSERT	ISO	GRADE	SPK-REF. NO.
CNGA 12 04 .. - L 	CNGA 12 04 04 T - LL	WXM 255	12.56.421.44.3
	CNGA 12 04 04 S - LL	WXM 355	12.56.421.46.4
	CNGA 12 04 04 S - LL	WXM 455	12.56.421.46.5
	CNGA 12 04 04 S - BL*	WBN 565	22.56.406.46.7
	CNGA 12 04 08 T - LL	WXM 255	12.56.422.44.3
	CNGA 12 04 08 S - LL	WXM 355	⊕12.56.422.46.4
	CNGA 12 04 08 S - LL	WXM 355	◇12.56.422.47.4
	CNGA 12 04 08 S - LL	WXM 455	12.56.422.46.5
	CNGA 12 04 08 S - BL*	WBN 565	22.56.407.46.7
	CNGA 12 04 12 T - LL	WXM 255	12.56.423.44.3
	CNGA 12 04 12 S - LL	WXM 355	⊕12.56.423.46.4
	CNGA 12 04 12 S - LL	WXM 355	◇12.56.423.47.4
	CNGA 12 04 12 S - LL	WXM 455	12.56.423.46.5
	CNGA 12 04 12 S - BL*	WBN 565	22.56.408.46.7
CNGA 12 04 08 - L - 95Z025 	CNGA 12 04 08 T - LL 95Z025	WXM 255	12.56.429.44.3
	CNGA 12 04 08 S - LL 95Z025	WXM 455	12.56.429.46.5
	CNGA 12 04 08 S - BL 95Z025*	WBN 565	22.54.496.46.7

* One-side, multi-tipped with two corners

i Chamfer geometries

T-chamfer:

for continuous cuts

❖ 44 for smooth cuts

S-chamfer: with rounding

⊕ 46 for lightly interrupted cuts

◇ 47 for heavily interrupted cuts



INSERT	ISO	GRADE	SPK-REF. NO.	
DCGW 07 02 .. - BL 	DCGW 07 02 04 T - BL	WXM 255	12.57.410.44.3	
	DCGW 07 02 04 S - BL	WXM 455	12.57.410.46.5	
	DCGW 07 02 04 S - BL	WBN 565	22.57.410.46.7	
	DCGW 07 02 08 T - BL	WXM 255	12.57.411.44.3	
	DCGW 07 02 08 S - BL	WXM 455	12.57.411.46.5	
DCGW 11 T3 .. - BL 	DCGW 11 T3 04 T - BL	WXM 255	12.57.408.44.3	
	DCGW 11 T3 04 S - BL	WXM 355	12.57.408.46.4	
	DCGW 11 T3 04 S - BL	WXM 455	12.57.408.46.5	
	DCGW 11 T3 04 S - BL	WBN 565	22.57.408.46.7	
	DCGW 11 T3 08 T - BL	WXM 255	12.57.409.44.3	
	DCGW 11 T3 08 S - BL	WXM 355	12.57.409.46.4	
	DCGW 11 T3 08 S - BL	WXM 355	12.57.409.47.4	
	DCGW 11 T3 08 S - BL	WXM 455	12.57.409.46.5	
	DCGW 11 T3 08 S - BL	WBN 565	22.57.409.46.7	
DNGA 15 04 .. - L 	DNGA 15 04 04 T - LL	WXM 255	12.56.430.44.3	
	DNGA 15 04 04 S - LL	WXM 455	12.56.430.46.5	
	DNGA 15 04 08 T - LL	WXM 255	12.56.431.44.3	
	DNGA 15 04 08 S - LL	WXM 355	12.56.431.46.4	
	DNGA 15 04 08 S - LL	WXM 455	12.56.431.46.5	
	DNGA 15 04 08 S - BL*	WBN 565	22.56.402.46.7	
	DNGA 15 04 12 S - LL	WXM 355	12.56.432.46.4	
DNGA 15 06 .. - L 	DNGA 15 06 04 T - LL	WXM 255	12.56.424.44.3	
	DNGA 15 06 04 S - LL	WXM 455	12.56.424.46.5	
	DNGA 15 06 08 T - LL	WXM 255	12.56.425.44.3	
	DNGA 15 06 08 S - LL	WXM 355	12.56.425.46.4	
	DNGA 15 06 08 S - LL	WXM 455	12.56.425.46.5	
	DNGA 15 06 08 S - BL*	WBN 565	22.56.405.46.7	
	DNGA 15 06 12 T - LL	WXM 255	12.56.426.44.3	
	DNGA 15 06 12 S - LL	WXM 355	12.56.426.46.4	
	DNGA 15 06 12 S - LL	WXM 355	12.56.426.47.4	
	DNGA 15 06 12 S - LL	WXM 455	12.56.426.46.5	
	DNGA 15 06 12 S - BL*	WBN 565	22.56.411.46.7	

* One-side, multi-tipped with two corners

Multi-tipped

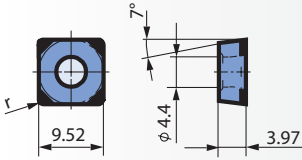
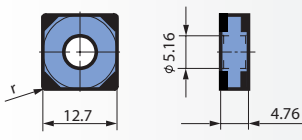
INSERT	ISO	GRADE	SPK-REF. NO.
SCGW 09 T3 .. - DL 	SCGW 09 T3 04 T - DL	WXM 255	12.17.419.44.3
	SCGW 09 T3 04 S - DL	WXM 355	12.17.419.46.4
	SCGW 09 T3 04 S - DL	WXM 455	12.17.419.46.5
	SCGW 09 T3 08 T - DL	WXM 255	12.17.420.44.3
	SCGW 09 T3 08 S - DL	WXM 355	12.17.420.46.4
	SCGW 09 T3 08 S - DL	WXM 455	12.17.420.46.5
	SCGW 09 T3 08 S - DL	WXM 455	12.17.420.46.5
SNGA 12 04 .. - L 	SNGA 12 04 04 T - NL	WXM 255	12.16.404.44.3
	SNGA 12 04 04 S - NL	WXM 455	12.16.404.46.5
	SNGA 12 04 08 T - NL	WXM 255	12.16.405.44.3
	SNGA 12 04 08 S - NL	WXM 355	⊕12.16.405.46.4
	SNGA 12 04 08 S - NL	WXM 355	⊕12.16.405.47.4
	SNGA 12 04 08 S - NL	WXM 455	12.16.405.46.5
	SNGA 12 04 08 S - DL*	WBN 565	22.16.402.46.7
	SNGA 12 04 12 T - NL	WXM 255	12.16.406.44.3
	SNGA 12 04 12 S - NL	WXM 355	12.16.406.46.4
	SNGA 12 04 12 S - NL	WXM 455	12.16.406.46.5
	SNGA 12 04 12 S - DL*	WBN 565	22.16.403.46.7

*One-side, multi-tipped with four corners

i Chamfer geometries

T-chamfer:

for continuous cuts

❖ 44 for smooth cuts

S-chamfer: with rounding

⊕ 46 for lightly

interrupted cuts

⊕ 47 for heavily interrupted cuts

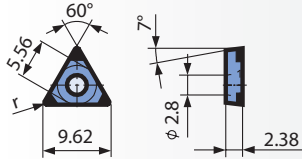
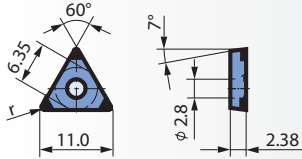
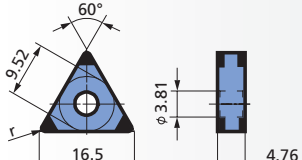

INSERT	ISO	GRADE	SPK-REF. NO.
TCGW 09 02 04 .. - CL 	TCGW 09 02 04 T - CL	WXM 255	12.37.405.44.3
	TCGW 09 02 04 S - CL	WXM 455	12.37.405.46.5
TCGW 11 02 .. - CL 	TCGW 11 02 04 T - CL	WXM 255	12.37.403.44.3
	TCGW 11 02 04 S - CL	WXM 355	12.37.403.46.4
	TCGW 11 02 04 S - CL	WXM 455	12.37.403.46.5
	TCGW 11 02 04 T - CL	WBN 565	22.37.403.44.7
	TCGW 11 02 08 T - CL	WXM 255	12.37.404.44.3
	TCGW 11 02 08 S - CL	WXM 355	12.37.404.46.4
	TCGW 11 02 08 S - CL	WXM 455	12.37.404.46.5
	TCGW 11 02 08 T - CL	WBN 565	22.37.404.44.7
TNGA 16 04 .. - L 	TNGA 16 04 04 T - ML	WXM 255	12.36.405.44.3
	TNGA 16 04 04 S - ML	WXM 455	12.36.405.46.5
	TNGA 16 04 08 T - ML	WXM 255	12.36.406.44.3
	TNGA 16 04 08 S - ML	WXM 355	⊙12.36.406.46.4
	TNGA 16 04 08 S - ML	WXM 355	◇12.36.406.47.4
	TNGA 16 04 08 S - ML	WXM 455	12.36.406.46.5
	TNGA 16 04 08 S - CL*	WBN 565	22.36.402.46.7
	TNGA 16 04 12 T - ML	WXM 255	12.36.407.44.3
	TNGA 16 04 12 S - ML	WXM 355	⊙12.36.407.46.4
	TNGA 16 04 12 S - ML	WXM 355	◇12.36.407.47.4
	TNGA 16 04 12 S - ML	WXM 455	12.36.407.46.5
	TNGA 16 04 12 S - CL*	WBN 565	22.36.403.46.7

* One-side, multi-tipped with three corners

Multi-tipped

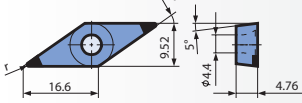
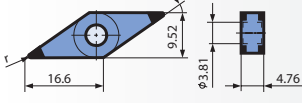
INSERT	ISO	GRADE	SPK-REF. NO.	
VBGW 16 04 .. - BL 	VBGW 16 04 02 S - BL	WXM 355	12.57.423.46.4	
	VBGW 16 04 02 T - BL	WBN 565	22.57.423.44.7	
	VBGW 16 04 04 T - BL	WXM 255	12.57.412.44.3	
	VBGW 16 04 04 S - BL	WXM 355	12.57.412.46.4	
	VBGW 16 04 04 S - BL	WXM 455	12.57.412.46.5	
	VBGW 16 04 04 T - BL	WBN 565	22.57.412.44.7	
	VBGW 16 04 08 T - BL	WXM 255	12.57.413.44.3	
	VBGW 16 04 08 S - BL	WXM 355	12.57.413.46.4	
	VBGW 16 04 08 S - BL	WXM 455	12.57.413.46.5	
	VBGW 16 04 08 S - BL	WBN 565	22.57.413.46.7	
	VBGW 16 04 12 T - BL	WXM 255	12.57.414.44.3	
	VBGW 16 04 12 S - BL	WXM 355	12.57.414.46.4	
	VBGW 16 04 12 S - BL	WXM 455	12.57.414.46.5	
	VNGA 16 04 .. - LL 	VNGA 16 04 04 T - LL	WXM 255	12.56.427.44.3
		VNGA 16 04 04 S - LL	WXM 455	12.56.427.46.5
VNGA 16 04 08 T - LL		WXM 255	12.56.428.44.3	
VNGA 16 04 08 S - LL		WXM 455	12.56.428.46.5	

i Chamfer geometries

T-chamfer:

for continuous cuts

❖ 44 for smooth cuts

S-chamfer: with rounding

⊙ 46 for lightly interrupted cuts

⊙ 47 for heavily interrupted cuts

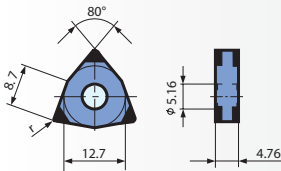

INSERT	ISO	GRADE	SPK-REF. NO.
WNGA 08 04 .. - ML 	WNGA 08 04 08 S - ML	WXM 355	⊕12.66.406.46.4
	WNGA 08 04 08 S - ML	WXM 355	⊖12.66.406.47.4
	WNGA 08 04 08 T - CL*	WBN 565	22.66.402.44.7
	WNGA 08 04 12 S - ML	WXM 355	⊕12.66.407.46.4
	WNGA 08 04 12 S - ML	WXM 355	⊖12.66.407.47.4
	WNGA 08 04 12 T - CL*	WBN 565	22.66.403.44.7

* One-side, multi-tipped with three corners

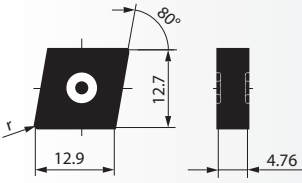
INSERT	ISO	GRADE	SPK-REF. NO.
CNGX 12 04 .. -S SDO 	CNGX 12 04 04 T-S SDO	WXM 255	❖12.52.086.44.3
	CNGX 12 04 04 S-S SDO	WXM 255	⊗12.52.086.46.3
	CNGX 12 04 04 S-S SDO	WXM 355	⊗12.52.086.46.4
	CNGX 12 04 04 S-S SDO	WXM 355	⋄12.52.086.47.4
	CNGX 12 04 08 T-S SDO	WXM 255	❖12.52.087.44.3
	CNGX 12 04 08 S-S SDO	WXM 255	⊗12.52.087.46.3
	CNGX 12 04 08 S-S SDO	WXM 355	⊗12.52.087.46.4
	CNGX 12 04 08 S-S SDO	WXM 355	⋄12.52.087.47.4
	CNGX 12 04 12 T-S SDO	WXM 255	❖12.52.088.44.3
	CNGX 12 04 12 S-S SDO	WXM 255	⊗12.52.088.46.3
	CNGX 12 04 12 S-S SDO	WXM 355	⊗12.52.088.46.4
	CNGX 12 04 12 S-S SDO	WXM 355	⋄12.52.088.47.4

i Chamfer geometries

T-chamfer:
for continuous cuts



❖ 44 for smooth cuts





S-chamfer: with rounding

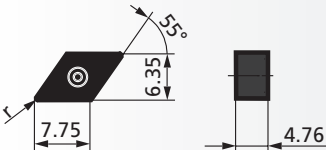
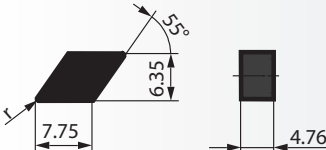
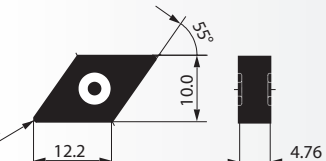

⊗ 46 for lightly interrupted cuts

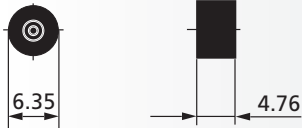
⋄ 47 for heavily interrupted cuts

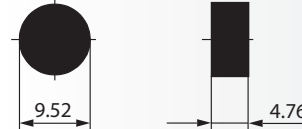
INSERT	ISO	GRADE	SPK-REF. NO.	
DNGX 07 04 .. -S MDO 	DNGX 07 04 04 S-S MDO	WXM 355	⊕12.52.062.46.4	
	DNGX 07 04 08 S-S MDO	WXM 355	⊕12.52.063.46.4	
	DNGX 07 04 08 S-S MDO	WXM 355	◇12.52.063.47.4	
	DNGX 07 04 12 S-S MDO	WXM 355	⊕12.52.064.46.4	
	DNGX 07 04 12 S-S MDO	WXM 355	◇12.52.064.47.4	
DNGN 07 04 .. -S 	DNGN 07 04 08 S-S	WXM 155	⊕12.52.098.46.2	
	DNGN 07 04 08 S-S	WXM 155	◇12.52.098.47.2	
	DNGN 07 04 12 S-S	WXM 155	⊕12.52.099.46.2	
	DNGN 07 04 12 S-S	WXM 155	◇12.52.099.47.2	
DNGX 12 04 .. -S SDO 	DNGX 12 04 08 T-S SDO	WXM 255	⊕12.52.090.44.3	
	DNGX 12 04 08 S-S SDO	WXM 255	⊕12.52.090.46.3	
	DNGX 12 04 08 S-S SDO	WXM 355	⊕12.52.090.46.4	
	DNGX 12 04 08 S-S SDO	WXM 355	◇12.52.090.47.4	
	DNGX 12 04 12 T-S SDO	WXM 255	⊕12.52.091.44.3	
	DNGX 12 04 12 S-S SDO	WXM 255	⊕12.52.091.46.3	
	DNGX 12 04 12 S-S SDO	WXM 355	⊕12.52.091.46.4	
	DNGX 12 04 12 S-S SDO	WXM 355	◇12.52.091.47.4	

INSERT	ISO	GRADE	SPK-BEST. NR.
RNGX 06 04 00 .. -S MDO 	RNGX 06 04 00 T-S MDO	WXM 255	12.42.035.44.3
	RNGX 06 04 00 S-S MDO	WXM 355	⊕12.42.035.46.4
	RNGX 06 04 00 S-S MDO	WXM 355	◇12.42.035.47.4
	RNGX 06 04 00 S-F* MDO	WXM 455	12.42.230.47.5
	* einseitig flächig belegt		
RNGN 06 04 00 .. -S 	RNGN 06 04 00 S-S	WXM 155	⊕12.42.042.46.2
	RNGN 06 04 00 S-S	WXM 155	◇12.42.042.47.2
RNGX 09 04 00 .. -S MDO 	RNGX 09 04 00 T-S MDO	WXM 255	12.42.036.44.3
	RNGX 09 04 00 S-S MDO	WXM 355	⊕12.42.036.46.4
	RNGX 09 04 00 S-S MDO	WXM 355	◇12.42.036.47.4
RNGN 09 04 00 .. -S 	RNGN 09 04 00 S-S	WXM 155	⊕12.42.043.46.2
	RNGN 09 04 00 S-S	WXM 155	◇12.42.043.47.2
RNGX 12 04 00 .. -S SDO 	RNGX 12 04 00 T-S SDO	WXM 255	❖12.42.038.44.3
	RNGX 12 04 00 S-S SDO	WXM 255	⊕12.42.038.46.3
	RNGX 12 04 00 S-S SDO	WXM 355	⊕12.42.038.46.4
	RNGX 12 04 00 S-S SDO	WXM 355	◇12.42.038.47.4

i Chamfer geometries

T-chamfer:

for continuous cuts

❖ 44 for smooth cuts

S-chamfer: with rounding

⊕ 46 for lightly interrupted cuts

◇ 47 for heavily interrupted cuts

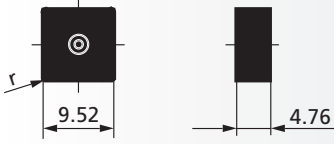
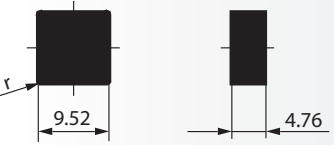
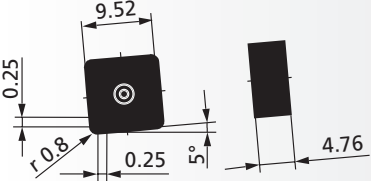

INSERT	ISO	GRADE	SPK-REF. NO.	
SNGX 09 04 ...-S MDO 	SNGX 09 04 08 T-S MDO	WXM 255	❖12.12.080.44.3	
	SNGX 09 04 08 S-S MDO	WXM 255	⊙12.12.080.46.3	
	SNGX 09 04 08 S-S MDO	WXM 355	⊙12.12.080.46.4	
	SNGX 09 04 08 S-S MDO	WXM 355	❖12.12.080.47.4	
	SNGX 09 04 12 T-S MDO	WXM 255	12.12.081.44.3	
	SNGX 09 04 12 S-S MDO	WXM 355	⊙12.12.081.46.4	
	SNGX 09 04 12 S-S MDO	WXM 355	❖12.12.081.47.4	
	SNGX 09 04 16 T-S MDO	WXM 255	12.12.082.44.3	
	SNGX 09 04 16 S-S MDO	WXM 355	⊙12.12.082.46.4	
	SNGX 09 04 16 S-S MDO	WXM 355	❖12.12.082.47.4	
	SNGN 09 04 ...-S 	SNGN 09 04 08 S-S	WXM 155	⊙12.12.065.46.2
		SNGN 09 04 08 S-S	WXM 155	❖12.12.065.47.2
SNGN 09 04 12 S-S		WXM 155	⊙12.12.066.46.2	
SNGN 09 04 12 S-S		WXM 155	❖12.12.066.47.2	
SNGN 09 04 16 S-S		WXM 155	⊙12.12.049.46.2	
SNGN 09 04 16 S-S		WXM 155	❖12.12.049.47.2	
SNGX 09 04 08 ...-S MDO 85Z025 	SNGX 09 04 08 T-S MDO 85Z025	WXM 255	12.12.083.44.3	
	SNGX 09 04 08 S-S MDO 85Z025	WXM 355	12.12.083.46.4	

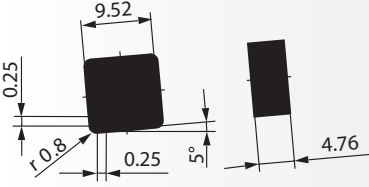
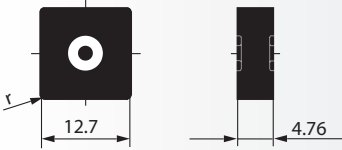
INSERT	ISO	GRADE	SPK-BEST. NR.
SNGN 09 04 08 .. -S 85Z025 	SNGN 09 04 08 S-S 85Z025	WXM 155	♣12.12.102.46.2
	SNGN 09 04 08 S-S 85Z025	WXM 155	♣12.12.102.47.2
SNGX 12 04 .. -S SDO 	SNGX 12 04 08 T-S SDO	WXM 255	♣12.12.090.44.3
	SNGX 12 04 08 S-S SDO	WXM 255	♣12.12.090.46.3
	SNGX 12 04 08 S-S SDO	WXM 355	♣12.12.090.46.4
	SNGX 12 04 08 S-S SDO	WXM 355	♣12.12.090.47.4
	SNGX 12 04 12 T-S SDO	WXM 255	♣12.12.091.44.3
	SNGX 12 04 12 S-S SDO	WXM 255	♣12.12.091.46.3
	SNGX 12 04 12 S-S SDO	WXM 355	♣12.12.091.46.4
	SNGX 12 04 12 S-S SDO	WXM 355	♣12.12.091.47.4

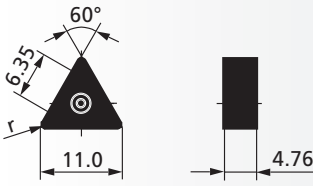
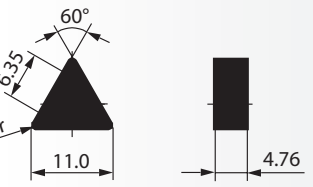
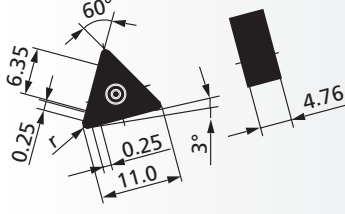
INSERT	ISO	GRADE	SPK-REF. NO.	
TNGX 11 04 ...-S MDO 	TNGX 11 04 04 T-S MDO	WXM 255	12.32.035.44.3	
	TNGX 11 04 04 S-S MDO	WXM 355	12.32.035.46.4	
	TNGX 11 04 08 T-S MDO	WXM 255	12.32.036.44.3	
	TNGX 11 04 08 S-S MDO	WXM 355	⊕12.32.036.46.4	
	TNGX 11 04 08 S-S MDO	WXM 355	◇12.32.036.47.4	
	TNGX 11 04 12 T-S MDO	WXM 255	12.32.037.44.3	
	TNGX 11 04 12 S-S MDO	WXM 355	⊕12.32.037.46.4	
	TNGX 11 04 12 S-S MDO	WXM 355	◇12.32.037.47.4	
	TNGX 11 04 16 T-S MDO	WXM 255	❖12.32.039.44.3	
	TNGX 11 04 16 S-S MDO	WXM 255	◇12.32.039.47.3	
	TNGX 11 04 16 S-S MDO	WXM 355	⊕12.32.039.46.4	
	TNGX 11 04 16 S-S MDO	WXM 355	◇12.32.039.47.4	
	TNGN 11 04 ...-S 	TNGN 11 04 08 S-S	WXM 155	⊕12.32.020.46.2
		TNGN 11 04 08 S-S	WXM 155	◇12.32.020.47.2
TNGN 11 04 12 S-S		WXM 155	⊕12.32.017.46.2	
TNGN 11 04 12 S-S		WXM 155	◇12.32.017.47.2	
TNGX 11 04 08 ...-S MDO 93Z025		TNGX 11 04 08 T-S MDO 93Z025	WXM 255	12.32.041.44.3
	TNGX 11 04 08 S-S MDO 93Z025	WXM 355	12.32.041.46.4	

SCHNEIDPLATTE	ISO	SORTE	SPK-BEST. NR.
TNGX 11 04 08 -S MDO 105Z025 	TNGX 11 04 08 T-S MDO 105Z025	WXM 255	12.32.038.44.3
	TNGX 11 04 08 S-S MDO 105Z025	WXM 355	12.32.038.46.4
TNGN 11 04 08 -S 105Z025 	TNGN 11 04 08 S-S 105Z025	WXM 155	⊕12.32.052.46.2
	TNGN 11 04 08 S-S 105Z025	WXM 155	⊖12.32.052.47.2
TNGX 16 04 ...-S SDO 	TNGX 16 04 04 T-S SDO	WXM 255	⊕12.32.046.44.3
	TNGX 16 04 04 S-S SDO	WXM 255	⊕12.32.046.46.3
	TNGX 16 04 04 S-S SDO	WXM 355	⊕12.32.046.46.4
	TNGX 16 04 04 S-S SDO	WXM 355	⊖12.32.046.47.4
	TNGX 16 04 08 T-S SDO	WXM 255	⊕12.32.047.44.3
	TNGX 16 04 08 S-S SDO	WXM 255	⊕12.32.047.46.3
	TNGX 16 04 08 S-S SDO	WXM 355	⊕12.32.047.46.4
	TNGX 16 04 08 S-S SDO	WXM 355	⊖12.32.047.47.4
	TNGX 16 04 12 T-S SDO	WXM 255	⊕12.32.048.44.3
	TNGX 16 04 12 S-S SDO	WXM 255	⊕12.32.048.46.3
	TNGX 16 04 12 S-S SDO	WXM 355	⊕12.32.048.46.4
	TNGX 16 04 12 S-S SDO	WXM 355	⊖12.32.048.47.4

i Chamfer geometries

T-chamfer:

for continuous cuts



⊕ 44 for smooth cuts

S-chamfer: with rounding



⊕ 46 for lightly interrupted cuts

⊖ 47 for heavily interrupted cuts

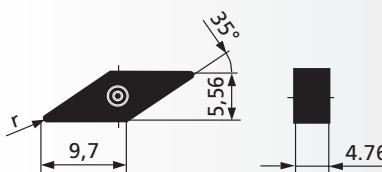
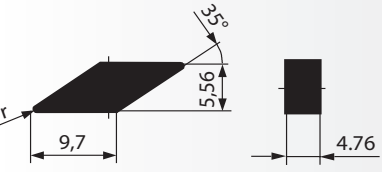
INSERT	ISO	GRADE	SPK-REF. NO.
VNGX 09 04 .. S-S MDO 	VNGX 09 04 04 S-S-MDO	WXM 355	12.52.065.46.4
	VNGX 09 04 08 S-S-MDO	WXM 355	12.52.066.46.4
	VNGX 09 04 12 S-S MDO	WXM 355	12.52.067.46.4
VNGN 09 04 .. S-S 	VNGN 09 04 08 S-S	WXM 155	⊕12.52.100.46.2
	VNGN 09 04 08 S-S	WXM 155	⊖12.52.100.47.2
	VNGN 09 04 12 S-S	WXM 155	⊕12.52.101.46.2
	VNGN 09 04 12 S-S	WXM 155	⊖12.52.101.47.2

IKS-PROMini

IKS-PROMini was designed especially for the hard turning of small dimensions using inserts from the new SPK HD-LINE generation of cutting materials. It is based on the proven IKS-PRO system. The consistent, ongoing development and adjustment of the notch and clamping element geometry has resulted in a clamping system that fulfills the very particular requirements of hard turning. The form-fit and force-fit connection between clamping element and insert ensures the retraction of the insert into the insert seating and guarantees an extremely stable and secure clamp for hard turning. At the same time, the cutting forces are optimally distributed across the entire insert seating and base. With varying cutting directions, the system holds the insert firmly in the insert seating and thereby ensures that the required positional and shape tolerances are met for components. This makes the

i Clamping technology

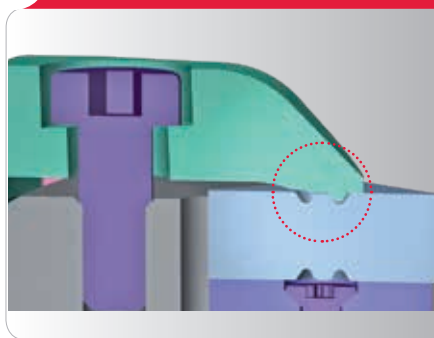

IKS-PROMini the ideal clamping system for achieving the most narrow tolerances with complete process reliability; from continuous to heavily interrupted cuts.

IKS-PROMini FOR HIGH PROCESS RELIABILITY

The new clamping system really shines when it comes to particularly complex machining operations, for example with varying machining directions, different cutting depths or heavily interrupted cuts. Regardless of the machining conditions, the insert must sit in the insert seating with the utmost security.

Together with the specially tailored cutting materials of the SPK HD-LINE, IKS-PROMini is the best choice for hard turning components with continuous to heavily interrupted cuts.





Shaft tools



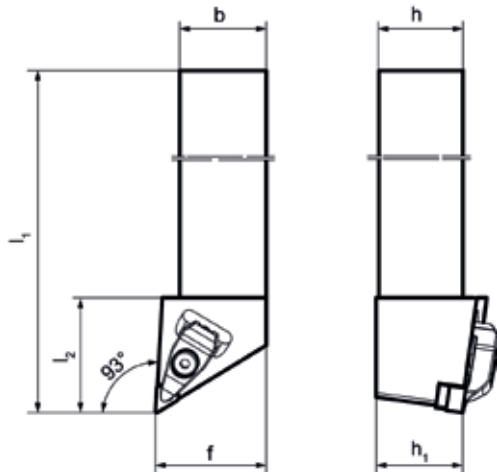

CDJN . 2525 M07 - ...



Shaft	Dimensions (mm)					
	h=h ₁	b	l ₁	l ₂	f	D _{min}
CDJN	25	25	150	33	32	350

Insert size	Torque	Torque	f, l, h dimensions measurement plate radius reference
DNG.. 07 04 ..	 3,5 Nm	 1,5 Nm	DN.. 07 04 08

Rake angle γ	- 5°
Setting angle λ	- 8°

INSERT	ISO	SPK REF.NO	Clamping element	Shim	
				For corner radius r	
 DNGX 07 04 - MDO	CDJN L 2525 M07 - MD4	719.24.001.03	70.91.11.850.0	0,4 / 0,8	70.91.22.425.0
	CDJN R 2525 M07 - MD4	719.23.001.03	70.91.11.850.0	1,2	70.91.22.426.0
 DNGN 07 04	CDJN L 2525 M07 - HDN4	719.24.001.23	70.91.11.851.0	0,4 / 0,8	70.91.22.425.0
	CDJN R 2525 M07 - HDN4	719.23.001.23	70.91.11.851.0	1,2	70.91.22.426.0

Note:
 Standard tool equipment: Shim for corner radius $r = 0.4 / 0.8$ mm.
 For corner radius $r = 1.2$ mm, please order shims separately!

Clamping element



70.91.55.215.0

Shim







33.60.0911.002.01

Shaft	Dimensions (mm)					
	h=h ₁	b	l ₁	l ₂	f	D _{min}
CRSN	25	25	150	33	32	400

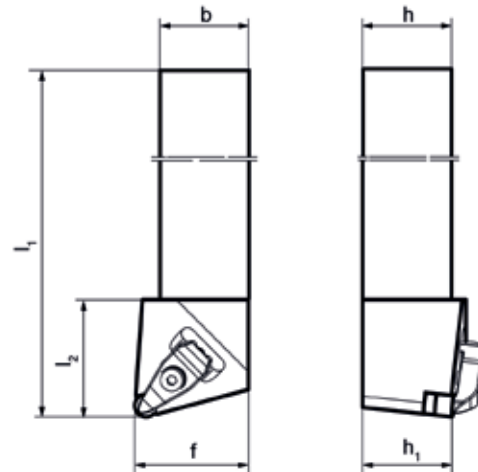
Insert size	Torque	Torque	f, l, h dimensions measurement plate radius reference
RNG.. 06 04 ..	3,5 Nm	1,5 Nm	—

Rake angle γ	- 6°
Setting angle λ	- 6°



INSERT	ISO	SPK REF.NO.	Clamping element	Shim	
				For corner radius r	
RNGX 06 04 - MDO 	CRSN L 2525 M06 - MD4	719.44.001.03	70.91.11.850.0	—	70.91.22.428.0
	CRSN R 2525 M06 - MD4	719.43.001.03	70.91.11.850.0		70.91.22.428.0
RNGN 06 04 	CRSN L 2525 M06 - HDN4	719.44.001.23	70.91.11.851.0	—	70.91.22.428.0
	CRSN R 2525 M06 - HDN4	719.43.001.23	70.91.11.851.0		70.91.22.428.0

Clamping element



70.91.55.215.0

Shim



33.60.0911.002.01

Shaft tools



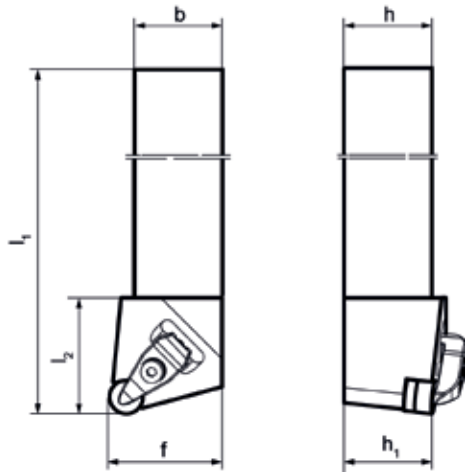

CRSN . 2525 M09 - ..



Shaft	Dimensions (mm)					
	h=h ₁	b	l ₁	l ₂	f	D _{min}
CRSN	25	25	150	33	32	400

Insert size	Torque	Torque	f, l, h dimensions measurement plate radius reference
RNG.. 09 04 ..	 3,5 Nm	 1,5 Nm	—

Rake angle γ	- 6°
Setting angle λ	- 6°

INSERT	ISO	SPK REF.NO.	Clamping element	Shim	
				For corner radius r	
RNGX 09 04 - MDO 	CRSN L 2525 M09 - MD4	719.44.002.03	70.91.11.850.0	—	70.91.22.427.0
	CRSN R 2525 M09 - MD4	719.43.002.03	70.91.11.850.0		70.91.22.427.0
RNGN 09 04 	CRSN L 2525 M09 - HDN4	719.44.002.23	70.91.11.851.0	—	70.91.22.427.0
	CRSN R 2525 M09 - HDN4	719.43.002.23	70.91.11.851.0		70.91.22.427.0

Clamping element Shim



70.91.55.215.0







33.60.0911.002.01

Shaft	Dimensions (mm)					
	$h=h_1$	b	l_1	l_2	f	D_{min}
CSYN	25	25	150	33	32	400

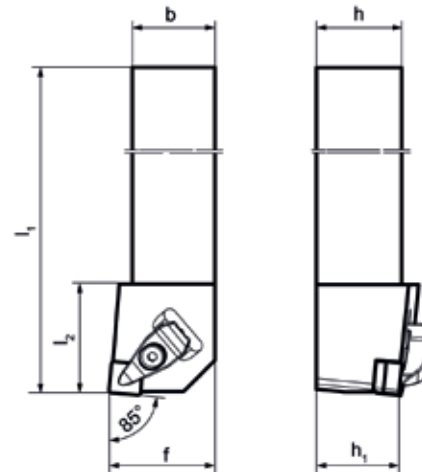
Insert size	Torque	Torque	f, l, h dimensions measurement plate radius reference
SNG.. 09 04 ..	 3,5 Nm	 1,5 Nm	SN.. 09 04 08

Rake angle γ	- 6°
Setting angle λ	- 4°



INSERT	ISO	SPK REF.NO.	Clamping element	Shim	
				For corner radius r	
SNGX 09 04 - MDO 	CSYN L 2525 M09 - MD4	719.04.002.03	70.91.11.850.0	0,4 / 0,8	70.91.22.430.0
	CSYN R 2525 M09 - MD4	719.03.002.03	70.91.11.850.0	1,2 / 1,6	70.91.22.431.0
SNGN 09 04 	CSYN L 2525 M09 - HDN4	719.04.002.23	70.91.11.851.0	0,4 / 0,8	70.91.22.430.0
	CSYN R 2525 M09 - HDN4	719.03.002.23	70.91.11.851.0	1,2 / 1,6	70.91.22.431.0

Note:

Standard tool equipment: Shim for corner radius $r = 0.4 / 0.8$ mm.
 For corner radius $r = 1.2/1.6$ mm, please order shims separately!

Clamping element



70.91.55.215.0

Shim



33.60.0911.002.01

Shaft tools



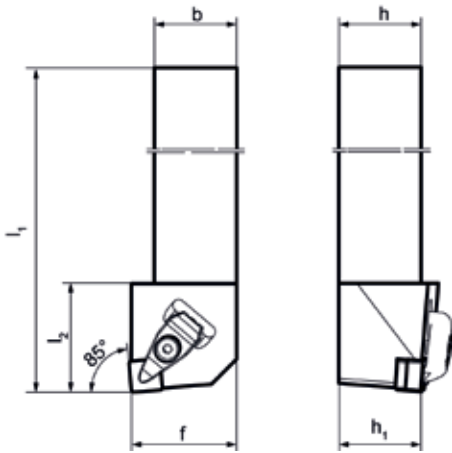

CSXN . 2525 M09 - ...



Shaft	Dimensions (mm)					
	h=h ₁	b	l ₁	l ₂	f	D _{min}
CSXN	25	25	150	33	32	400

Insert size	Torque	Torque	f, l, h dimensions measurement plate radius reference
SNG.. 09 04 ..	 3,5 Nm	 1,5 Nm	SN.. 09 04 08

Rake angle γ	- 6°
Setting angle λ	- 4°

INSERT	ISO	SPK REF.NO.	Clamping element	Shim	
				For corner radius r	
 SNGX 09 04 - MDO	CSXN L 2525 M09 - MD4	719.04.001.03	70.91.11.850.0	0,4 / 0,8	70.91.22.430.0
	CSXN R 2525 M09 - MD4	719.03.001.03	70.91.11.850.0	1,2 / 1,6	70.91.22.431.0
 SNGN 09 04	CSXN L 2525 M09 - HDN4	719.04.001.23	70.91.11.851.0	0,4 / 0,8	70.91.22.430.0
	CSXN R 2525 M09 - HDN4	719.03.001.23	70.91.11.851.0	1,2 / 1,6	70.91.22.431.0

Note:
 Standard tool equipment: Shim for corner radius $r = 0.4 / 0.8$ mm.
 For corner radius $r = 1.2/1.6$ mm, please order shims separately!

Clamping element

Shim



70.91.55.215.0







33.60.0911.002.01

Shaft	Dimensions (mm)					
	$h=h_1$	b	l_1	l_2	f	D_{min}
CTGN	25	25	150	33	32	300

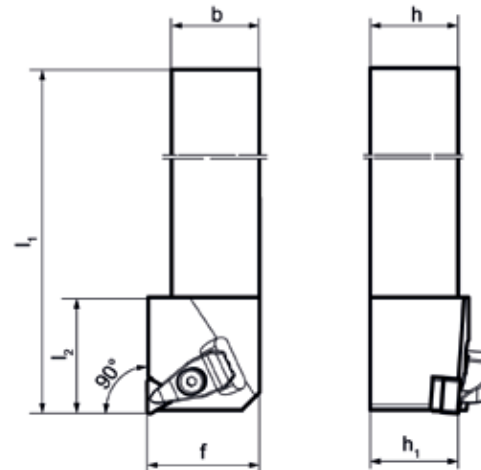
Insert size	Torque	Torque	f, l, h dimensions measurement plate radius reference
TNG.. 11 04 ..	 3,5 Nm	 1,5 Nm	TN.. 11 04 08

Rake angle γ	- 6°
Setting angle λ	- 4°



INSERT	ISO	SPK REF.NO.	Clamping element	Shim	
				For corner radius r	
TNGX 11 04 - MDO 	CTGN L 2525 M11 - MD4	719.14.001.03	70.91.11.850.0	0,4 / 0,8	70.91.22.434.0
	CTGN R 2525 M11 - MD4	719.13.001.03	70.91.11.850.0	1,2 / 1,6	70.91.22.435.0
TNGN 11 04 	CTGN L 2525 M11 - HDN4	719.14.001.23	70.91.11.851.0	0,4 / 0,8	70.91.22.434.0
	CTGN R 2525 M11 - HDN4	719.13.001.23	70.91.11.851.0	1,2 / 1,6	70.91.22.435.0

Note:

Standard tool equipment: Shim for corner radius $r = 0.4 / 0.8$ mm.
 For corner radius $r = 1.2/1.6$ mm, please order shims separately!

Clamping element



70.91.55.215.0

Shim



33.60.0911.002.01

Shaft tools



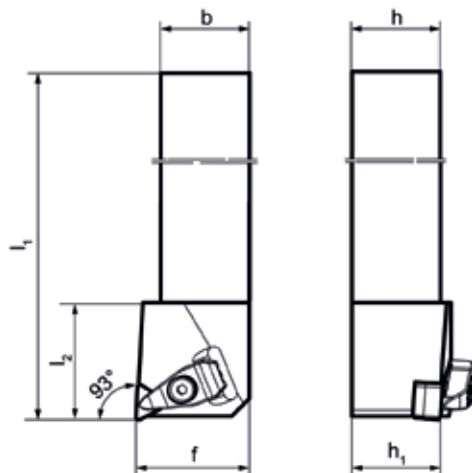

CTJN . 2525 M11 - ...



Shaft	Dimensions (mm)					
	$h=h_1$	b	l_1	l_2	f	D_{min}
CTJN	25	25	150	33	32	300

Insert size	Torque	Torque	f, l, h dimensions measurement plate radius reference
TNG.. 11 04 ..	3,5 Nm	1,5 Nm	TN.. 11 04 08

Rake angle γ	- 6°
Setting angle λ	- 4°

INSERT	ISO	SPK REF.NO.	Clamping element	Shim	
				For corner radius r	
 TNGX 11 04 - MDO	CTJN L 2525 M11 - MD4	719.14.002.03	70.91.11.850.0	0,4 / 0,8	70.91.22.434.0
	CTJN R 2525 M11 - MD4	719.13.002.03	70.91.11.850.0	1,2 / 1,6	70.91.22.435.0
 TNGN 11 04	CTJN L 2525 M11 - HDN4	719.14.002.23	70.91.11.851.0	0,4 / 0,8	70.91.22.434.0
	CTJN R 2525 M11 - HDN4	719.13.002.23	70.91.11.851.0	1,2 / 1,6	70.91.22.435.0

Note:
 Standard tool equipment: Shim for corner radius $r = 0.4 / 0.8$ mm.
 For corner radius $r = 1.2/1.6$ mm, please order shims separately!

Clamping element

Shim



70.91.55.215.0





33.60.0911.002.01

Shaft	Dimensions (mm)					
	$h=h_1$	b	l_1	l_2	f	D_{min}
CVJN	25	25	150	40	32	350

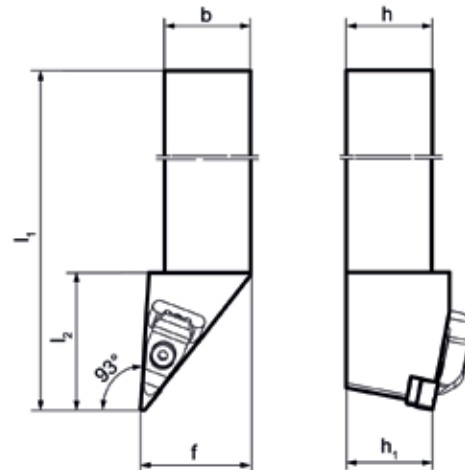
Insert size	Torque	Torque	f, l, h dimensions measurement plate radius reference
VNG.. 09 04 ..	 3,5 Nm	 1,5 Nm	VN.. 09 04 08

Rake angle γ	- 4°
Setting angle λ	- 11°



INSERT	ISO	SPK REF.NO.	Clamping element	Shim	
				For corner radius r	
 VNGX 09 04 - MDO	CVJN L 2525 M09 - MD4	719.24.002.03	70.91.11.850.0	0,4	70.91.22.443.0
	CVJN R 2525 M09 - MD4	719.23.002.03	70.91.11.850.0	0,8	70.91.22.438.0
 VNGN 09 04	CVJN L 2525 M09 - HDN4	719.24.002.23	70.91.11.851.0	1,2	70.91.22.439.0
	CVJN R 2525 M09 - HDN4	719.23.002.23	70.91.11.851.0	0,4	70.91.22.443.0
					0,8
				1,2	70.91.22.439.0

Note:
 Standard tool equipment: Shim for corner radius $r = 0.4 / 0.8$ mm.
 For corner radius $r = 1.2$ mm, please order shims separately!

Clamping element

Shim



70.91.55.215.0

33.60.0911.002.01



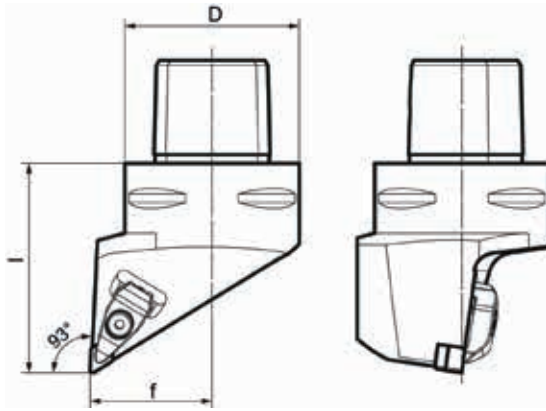

CMS5 - CDJN . 35060 - 07 - ...



Shaft	Dimensions (mm)			
	d	f	l	D _{min}
CMS 5	50	35	60	320

Insert size	Torque	Torque	f, l, h dimensions measurement plate radius reference
DNG.. 07 04 ..	 3,5 Nm	 1,5 Nm	DN .. 07 04 08

Rake angle γ	- 5°
Setting angle λ	- 8°

INSERT	ISO	SPK REF.NO.	Clamping element	Shim	
				For corner radius r	
DNGX 07 04 - MDO 	CMS5 - CDJN L 35060 - 07 - MD4	799.24.001.13	70.91.11.850.0	0,4 / 0,8	70.91.22.425.0
	CMS5 - CDJN R 35060 - 07 - MD4	799.23.001.13	70.91.11.850.0	1,2	70.91.22.426.0
DNGN 07 04 	CMS5 - CDJN L 35060 - 07 - HDN4	799.24.001.23	70.91.11.851.0	0,4 / 0,8	70.91.22.425.0
	CMS5 - CDJN R 35060 - 07 - HDN4	799.23.001.23	70.91.11.851.0	1,2	70.91.22.426.0

Note:
 Standard tool equipment: Shim for corner radius $r = 0.4 / 0.8$ mm.
 For corner radius $r = 1.2$ mm, please order shims separately!

Clamping element

Shim



70.91.55.215.0





33.60.0911.002.01

Shaft	Dimensions (mm)			
	d	f	l	D _{min}
CMS 5	50	35	60	310

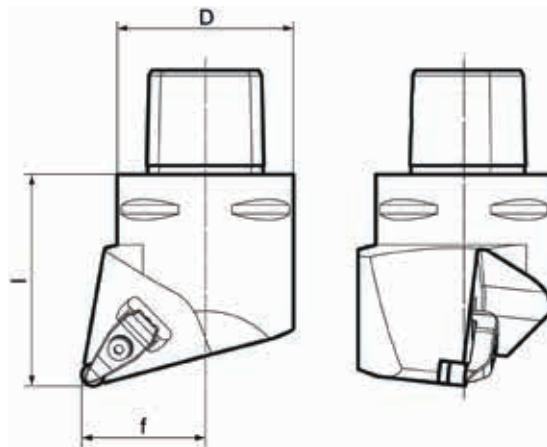
Insert size	Torque	Torque	f, l, h dimensions measurement plate radius reference
RNG.. 06 04 ..	 3,5 Nm	 1,5 Nm	—

Rake angle γ	- 6°
Setting angle λ	- 6°



INSERT	ISO	SPK REF.NO.	Spare parts	Shim	
				For corner radius r	
RNGX 06 04 - MDO 	CMS5 - CRSN L 35060 - 06 - MD4	799.44.001.13	70.91.11.850.0	—	70.91.22.428.0
	CMS5 - CRSN R 35060 - 06 - MD4	799.43.001.13	70.91.11.850.0		70.91.22.428.0
RNGN 06 04 	CMS5 - CRSN L 35060 - 06 - HDN4	799.44.001.23	70.91.11.851.0	—	70.91.22.428.0
	CMS5 - CRSN R 35060 - 06 - HDN4	799.43.001.23	70.91.11.851.0		70.91.22.428.0

Clamping element

Shim



70.91.55.215.0

33.60.0911.002.01



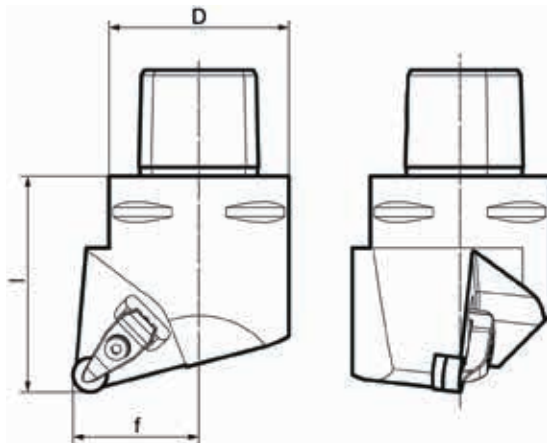

CMS5 - CRSN . 35060 - 09 - ...



Shaft	Dimensions (mm)			
	d	f	l	D _{min}
CMS 5	50	35	60	310

Insert size	Torque	Torque	f, l, h dimensions measurement plate radius reference
RNG.. 09 04 ..	 3,5 Nm	 1,5 Nm	—

Rake angle γ	- 6°
Setting angle λ	- 6°

INSERT	ISO	SPK REF.NO.	Clamping element	Shim	
				For corner radius r	
RNGX 09 04 - MDO 	CMS5 - CRSN L 35060 - 09 - MD4	799.44.002.13	70.91.11.850.0	—	70.91.22.427.0
	CMS5 - CRSN R 35060 - 09 - MD4	799.43.002.13	70.91.11.850.0		70.91.22.427.0
RNGN 09 04 	CMS5 - CRSN L 35060 - 09 - HDN4	799.44.002.23	70.91.11.851.0	—	70.91.22.427.0
	CMS5 - CRSN R 35060 - 09 - HDN4	799.43.002.23	70.91.11.851.0		70.91.22.427.0

Clamping element

Shim



70.91.55.215.0







33.60.0911.002.01

Shaft	Dimensions (mm)			
	d	f	l	D _{min}
CMS 5	50	35	60	320

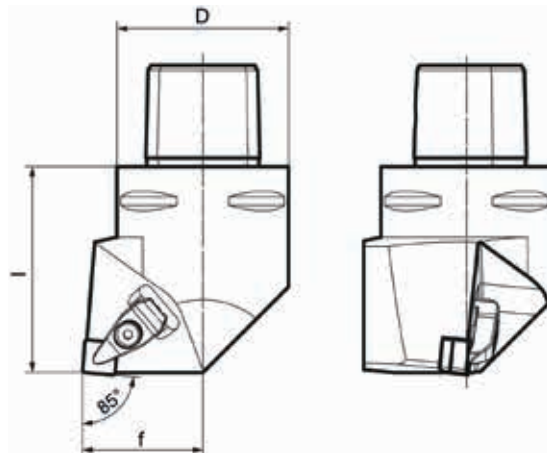
Insert size	Torque	Torque	f, l, h dimensions measurement plate radius reference
SNG.. 09 04 ..	 3,5 Nm	 1,5 Nm	SN .. 09 04 08

Rake angle γ	- 6°
Setting angle λ	- 4°



INSERT	ISO	SPK REF.NO.	Clamping element	Shim	
				For corner radius r	
SNGX 09 04 - MDO 	CMS5 - CSYN L 35060 - 09 - MD4	799.04.002.13	70.91.11.850.0	0,4 / 0,8	70.91.22.430.0
	CMS5 - CSYN R 35060 - 09 - MD4	799.03.002.13	70.91.11.850.0	1,2 / 1,6	70.91.22.431.0
SNGN 09 04 	CMS5 - CSYN L 35060 - 09 - HDN4	799.04.002.23	70.91.11.851.0	0,4 / 0,8	70.91.22.430.0
	CMS5 - CSYN R 35060 - 09 - HDN4	799.03.002.23	70.91.11.851.0	1,2 / 1,6	70.91.22.431.0

Note:
 Standard tool equipment: Shim for corner radius $r = 0.4 / 0.8$ mm.
 For corner radius $r = 1.2/1.6$ mm, please order shims separately!

Clamping element



70.91.55.215.0

Shim



33.60.0911.002.01



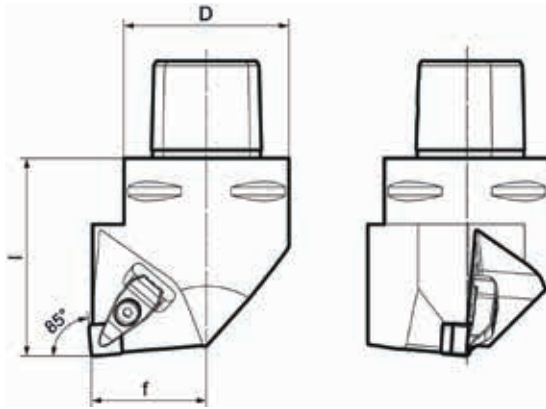

CMS5 - CSXN . 35060 - 09 - ...



Shaft	Dimensions (mm)			
	d	f	l	D _{min}
CMS 5	50	35	60	310

Insert size	Torque	Torque	f, l, h dimensions measurement plate radius reference
SNG.. 09 04 ..	 3,5 Nm	 1,5 Nm	SN .. 09 04 08

Rake angle γ	- 6°
Setting angle λ	- 4°

INSERT	ISO	SPK REF.NO.	Clamping element	Shim	
				For corner radius r	
SNGX 09 04 - MDO 	CMS5 - CSXN L 35060 - 09 - MD4	799.04.001.13	70.91.11.850.0	0,4 / 0,8	70.91.22.430.0
	CMS5 - CSXN R 35060 - 09 - MD4	799.03.001.13	70.91.11.850.0	1,2 / 1,6	70.91.22.431.0
SNGN 09 04 	CMS5 - CSXN L 35060 - 09 - HDN4	799.04.001.23	70.91.11.851.0	0,4 / 0,8	70.91.22.430.0
	CMS5 - CSXN R 35060 - 09 - HDN4	799.03.001.23	70.91.11.851.0	1,2 / 1,6	70.91.22.431.0

Note:
 Standard tool equipment: Shim for corner radius r = 0.4 / 0.8 mm.
 For corner radius r = 1.2/1.6 mm, please order shims separately!





Clamping element	Shim
 SW 2,5	 TX 8
70.91.55.215.0	33.60.0911.002.01

Shaft	Dimensions (mm)			
	d	f	l	D _{min}
CMS 5	50	35	60	320

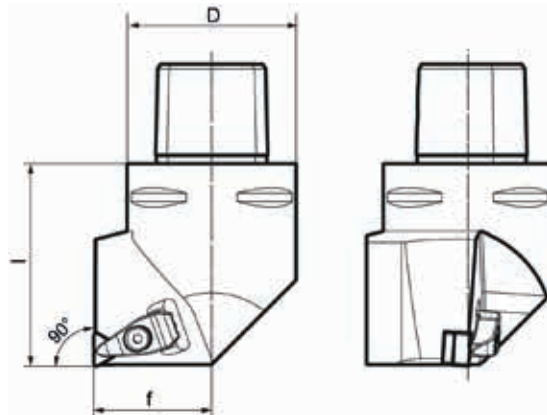
Insert size	Torque	Torque	f, l, h dimensions measurement plate radius reference
TNG.. 11 04 ..	 3,5 Nm	 1,5 Nm	TN .. 11 04 08

Rake angle γ	- 6°
Setting angle λ	- 4°



INSERT	ISO	SPK REF.NO.	Clamping element	Shim	
				For corner radius r	
TNGX 11 04 - MDO 	CMS5 - CTGN L 35060 - 11 - MD4	799.14.001.13	70.91.11.850.0	0,4 / 0,8	70.91.22.434.0
	CMS5 - CTGN R 35060 - 11 - MD4	799.13.001.13	70.91.11.850.0	1,2 / 1,6	70.91.22.435.0
TNGN 11 04 	CMS5 - CTGN L 35060 - 11 - HDN4	799.14.001.23	70.91.11.851.0	0,4 / 0,8	70.91.22.434.0
	CMS5 - CTGN R 35060 - 11 - HDN4	799.13.001.23	70.91.11.851.0	1,2 / 1,6	70.91.22.435.0

Note:
 Standard tool equipment: Shim for corner radius $r = 0.4 / 0.8$ mm.
 For corner radius $r = 1.2/1.6$ mm, please order shims separately!

Clamping element

Shim

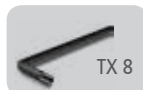

70.91.55.215.0

33.60.0911.002.01



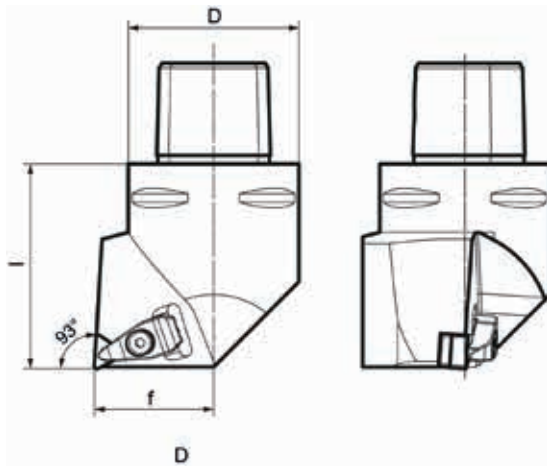

CMS5 - CTJN . 35060 - ...



Shaft	Dimensions (mm)			
	d	f	l	D _{min}
CMS 5	50	35	60	320

Insert size	Torque	Torque	f, l, h dimensions measurement plate radius reference
TNG.. 11 04 ..	 3,5 Nm	 1,5 Nm	TN .. 11 04 08

Rake angle γ	- 6°
Setting angle λ	- 4°

INSERT	ISO	SPK REF.NO.	Clamping element	Shim	
				For corner radius r	
 TNGX 11 04 - MDO	CMS5 - CTJN L 35060 - 11 - MD4	799.14.002.13	70.91.11.850.0	0,4 / 0,8	70.91.22.434.0
	CMS5 - CTJN R 35060 - 11 - MD4	799.13.002.13	70.91.11.850.0	1,2 / 1,6	70.91.22.435.0
 TNGN 11 04	CMS5 - CTJN L 35060 - 11 - HDN4	799.14.002.23	70.91.11.851.0	0,4 / 0,8	70.91.22.434.0
	CMS5 - CTJN R 35060 - 11 - HDN4	799.13.002.23	70.91.11.851.0	1,2 / 1,6	70.91.22.435.0

Note:
 Standard tool equipment: Shim for corner radius $r = 0.4 / 0.8$ mm.
 For corner radius $r = 1.2/1.6$ mm, please order shims separately!

Clamping element

Shim



70.91.55.215.0







33.60.0911.002.01

Shaft	Dimensions (mm)			
	d	f	l	D _{min}
CMS 5	50	35	60	320

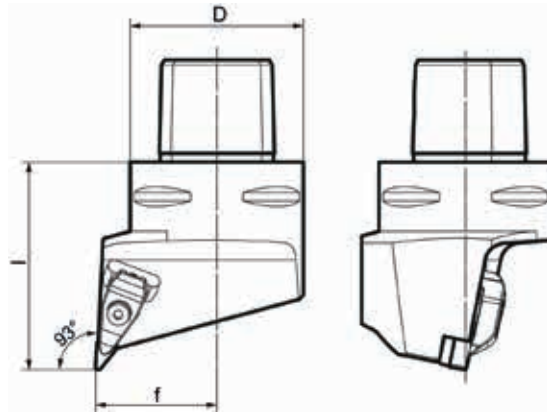
Insert size	Torque	Torque	f, l, h dimensions measurement plate radius reference
VNG.. 09 04 ..	 3,5 Nm	 1,5 Nm	VN .. 09 04 08

Rake angle γ	- 4°
Setting angle λ	- 11°



INSERT	ISO	SPK REF.NO.	Spare parts	Shim	
				For corner radius r	
VNGX 09 04 - MDO 	CMS5 - CVJN L 35060 - 09 - MD4	799.24.002.13	70.91.11.850.0	0,4	70.91.22.443.0
	CMS5 - CVJN R 35060 - 09 - MD4	799.23.002.13	70.91.11.850.0	0,8	70.91.22.438.0
VNGN 09 04 	CMS5 - CVJN L 35060 - 09 - HDN4	799.24.002.23	70.91.11.851.0	1,2	70.91.22.439.0
	CMS5 - CVJN R 35060 - 09 - HDN4	799.23.002.23	70.91.11.851.0	0,4	70.91.22.443.0
				0,8	70.91.22.438.0
				1,2	70.91.22.439.0

Note:
 Standard tool equipment: Shim for corner radius r = 0.4 / 0.8 mm.
 For corner radius r = 1.2 mm, please order shims separately!

Clamping element

Shim



70.91.55.215.0

33.60.0911.002.01

Boring bars



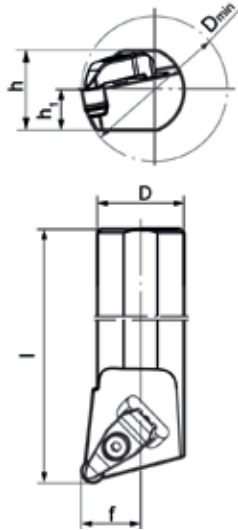

S25M - CRSN . 06 - ...



Shaft	Dimensions (mm)					
	d	h ₁	l	h	f	D _{min}
S25M	25	11,5	250	23	17	42

Insert size	Torque	Torque	f, l, h dimensions measurement plate radius reference
RNG.. 06 04 ..	 3,5 Nm	 1,5 Nm	—

Rake angle γ	- 10°
Setting angle λ	- 6°

INSERT	ISO	SPK REF.NO.	Clamping element	Shim	
				For corner radius r	
RNGX 06 04 - MDO 	S25M - CRSN L 06 - MD4	759.44.001.03	70.91.11.850.0	—	70.91.22.429.0
	S25M - CRSN R 06 - MD4	759.43.001.03	70.91.11.850.0		70.91.22.429.0
RNGN 06 04 	S25M - CRSN L 06 - HDN4	759.44.001.23	70.91.11.851.0	—	70.91.22.429.0
	S25M - CRSN R 06 - HDN4	759.43.001.23	70.91.11.851.0		70.91.22.429.0

Clamping element



70.91.55.215.0

Shim







33.60.0911.002.01

Shaft	Dimensions (mm)					
	d	h ₁	l	h	f	D _{min}
S25M	25	11,5	250	23	17	42

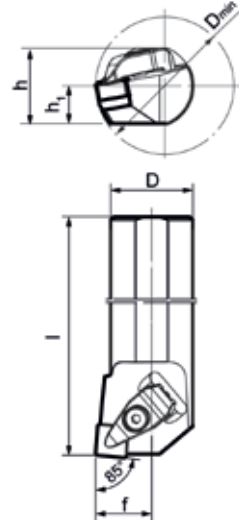
Insert size	Torque	Torque	f, l, h dimensions measurement plate radius reference
SNG.. 09 04 ..	 3,5 Nm	 1,5 Nm	SN .. 09 04 08

Rake angle γ	- 6°
Setting angle λ	- 10°

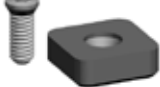

INSERT	ISO	SPK REF.NO.	Spare parts	Shim	
				For corner radius r	
SNGX 09 04 - MDO 	S25M - CSYN L 09 - MD4	759.04.002.03	70.91.11.850.0	0,4 / 0,8	70.91.22.432.0
	S25M - CSYN R 09 - MD4	759.03.002.03	70.91.11.850.0	1,2 / 1,6	70.91.22.433.0
SNGN 09 04 	S25M - CSYN L 09 - HDN4	759.04.002.23	70.91.11.851.0	0,4 / 0,8	70.91.22.432.0
	S25M - CSYN R 09 - HDN4	759.03.002.23	70.91.11.851.0	1,2 / 1,6	70.91.22.433.0

Note:
 Standard tool equipment: Shim for corner radius $r = 0.4 / 0.8$ mm.
 For corner radius $r = 1.2/1.6$ mm, please order shims separately!

Clamping element



70.91.55.215.0

Shim



33.60.0911.002.01

Boring bars

S25M - CTJN . 11 - ...

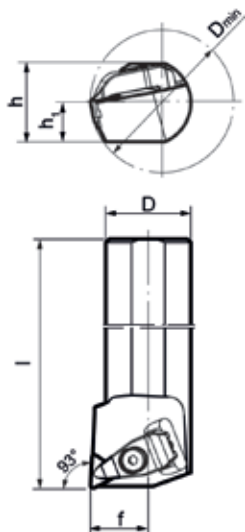





Shaft	Dimensions 41 (mm)					
	d	h ₁	l	h	f	D _{min}
S25M	25	11,5	250	23	17	42

Insert size	Torque	Torque	f, l, h dimensions measurement plate radius reference
TNG.. 11 04 ..	 3,5 Nm	 1,5 Nm	TN.. 11 04 08

Rake angle γ - 10°

Setting angle λ - 6°

Insert	Bezeichnung	SPK-Best. Nr.	Clamping element	Shim	
				For corner radius r	
 TNGX 11 04 - MDO	S25M - CTJN L 11 - MD4	759.14.002.03	70.91.11.850.0	0,4 / 0,8	70.91.22.436.0
	S25M - CTJN R 11 - MD4	759.13.002.03	70.91.11.850.0	1,2 / 1,6	70.91.22.437.0
 TNGN 11 04	S25M - CTJN L 11 - HDN4	759.14.002.23	70.91.11.851.0	0,4 / 0,8	70.91.22.436.0
	S25M - CTJN R 11 - HDN4	759.13.002.23	70.91.11.851.0	1,2 / 1,6	70.91.22.437.0

Note:
 Standard tool equipment: Shim for corner radius $r = 0.4 / 0.8$ mm.
 For corner radius $r = 1.2 / 1.6$ mm, please order shims separately!

Clamping element

Shim



70.91.55.215.0



33.60.0911.002.01

S3 tool system for solid PcBN with large inscribed circle (≥ 12.70 mm)

The S3 clamping system is available for solid PcBN inserts with large inscribed circle. For selecting the type, refer to the S3 catalogue, which is available separately and can be downloaded as a PDF from the Internet.

www.spk-tools.com

PLEASE NOTE

Corresponding clamping elements for S3 tools must be ordered separately.
They are available in standard and carbide metal versions. See the table below.

EXAMPLE ORDER:

You order the S3 tool S3 - CMS5 - CCLNL .., using the SPK order number 798.24.038.11

When ordering, you specify which clamping element you would like to use (standard or carbide metal).

- for standard clamping element: 70.91.11.830.0

- for carbide metal clamping element: 70.91.11.880.0

Overview of solid PcBN insert types with large inscribed circle (≥ 12.70 mm) and corresponding clamping elements

Insert Type	Page	Clamping element	
		Standard	Carbide metal
CNGX 12 04 .. – S SDO	26	70.91.11.830.0	70.91.11.880.0
DNGX 12 04 .. – S SDO	27	70.91.11.830.0	70.91.11.880.0
RNGX 12 04 .. – S SDO	28	70.91.11.830.0	70.91.11.880.0
SNGX 12 04 .. – S SDO	30	70.91.11.830.0	70.91.11.880.0
TNGX 16 04 .. – S SDO	32	70.91.11.830.0	70.91.11.880.0

